

# TAKING MAKING INTO CLASSROOMS:

# OCEAN TOOLKIT

Compiled by Dr. Sherry Scully and Anna Naylor

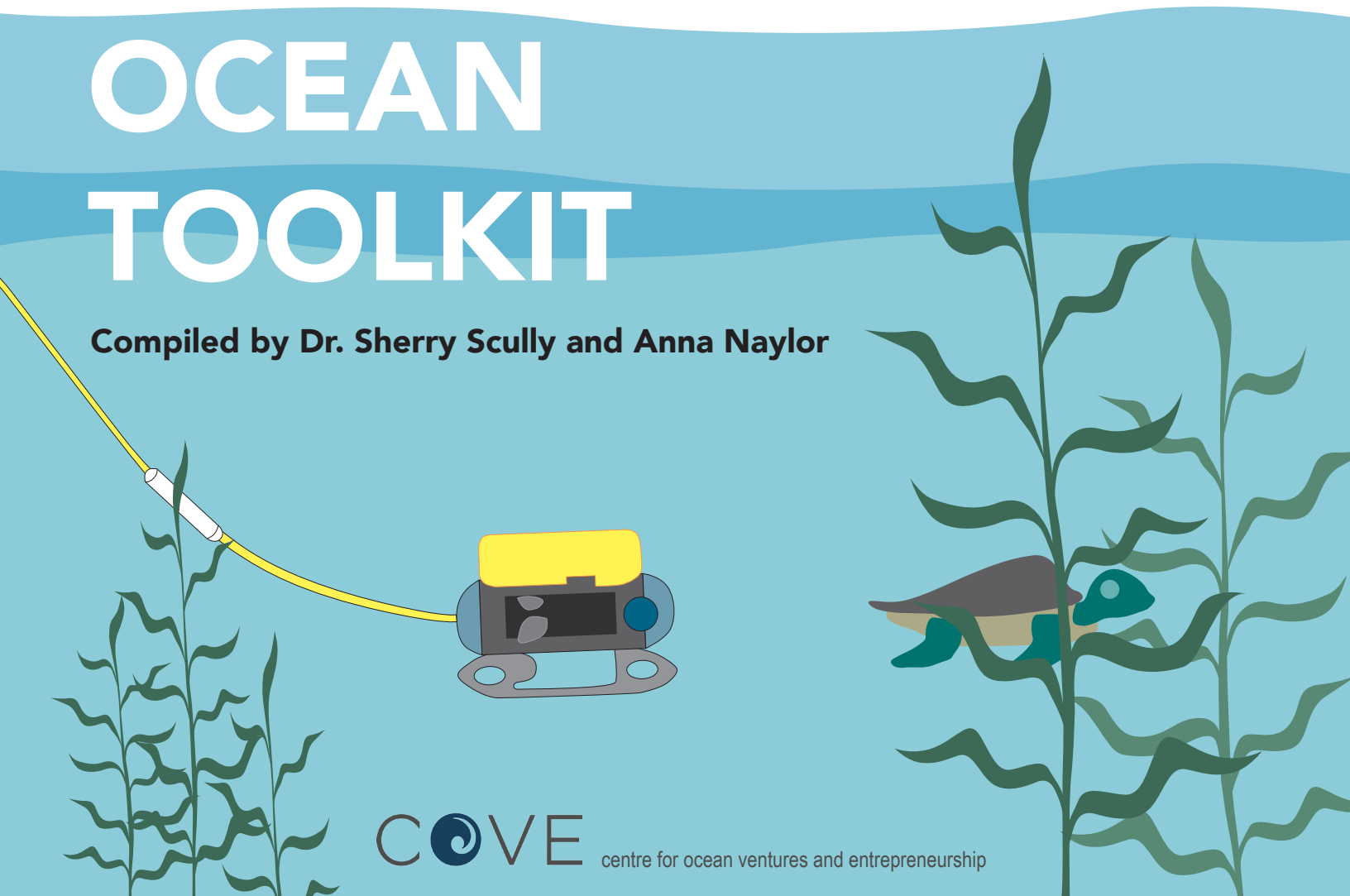
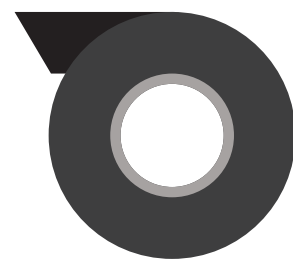
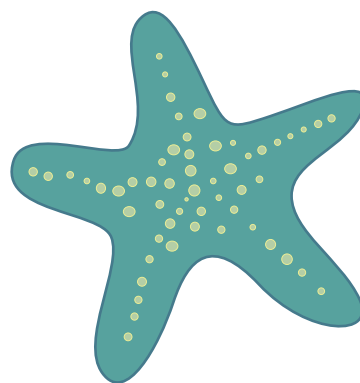
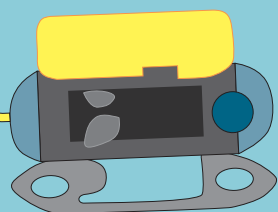

## CONTENTS

Taking Making into Classrooms.....	4
The Maker Movement and its Place in North American Lives.....	7
Scope and Range of Maker Activities....	11
Making the Connection: Designing, Making and a New Culture of Learning.....	12
Two Mindsets.....	13
Fostering an Intentional Mindset.....	15
Fostering Students' Growth through Reflection & Formative Dialogue.....	16
Design Challenges: Prompts for Learning and Hard Fun.....	17
Design Challenge Components and Descriptions.....	19
Crafting a Design Challenge.....	22
Assessment: Reimagining Ways to Value Process, Product, Creativity & Learning.....	24
Honouring the Parts that Make the Process Whole.....	26
Fostering Habits of Mind.....	29
Safety Issues.....	32
Mapping Learning Intentions, Tools and Safety.....	33
Suggested Resources.....	35



## GRADES

Please note that each activity shows the grade that the activity was originally designed for. This provides context for the learning outcomes and complexity level of the activity. We encourage teachers to modify (*simplify or extend*) for other grade levels as well.

# OCEAN TOOLKIT MODULES

<b>Design Challenge 1:</b> Where did my Beach go?.....	38
<b>Design Challenge 2:</b> Inhabiting Atlantis / Finding a home.....	40
<b>Design Challenge 3:</b> Water Water Everywhere, But Not a Drop to Drink!.....	42
<b>Design Challenge 4:</b> Protecting Sea Turtle Eggs.....	44
<b>Design Challenge 5:</b> Shipwrecked.....	46
<b>Design Challenge 6:</b> Designing Ocean-Friendly Products.....	48
<b>Design Challenge 7:</b> Turtle Patrol.....	50
<b>Design Challenge 8:</b> Ocean Friends.....	54
<b>Design Challenge 9:</b> Underwater Exploration: Designing Underwater DIY Waterproof Cameras.....	56
<b>Design Challenge 10:</b> Ocean Design Challenge.....	58
<b>Skill-Building Activity:</b> Building a Ship's Hull.....	61
<b>Assembly Mega Block 1</b> .....	65-71
<b>Assembly Mega Block 2</b> .....	72-78
<b>Assembly Mega Block 3</b> .....	79-84
<b>Final Assembly</b> .....	85-86

# TEACHER RESOURCES

Facilitator Guide for Design Thinking.....	87
Fillable Student Workbook.....	91
Placemat.....	92-93

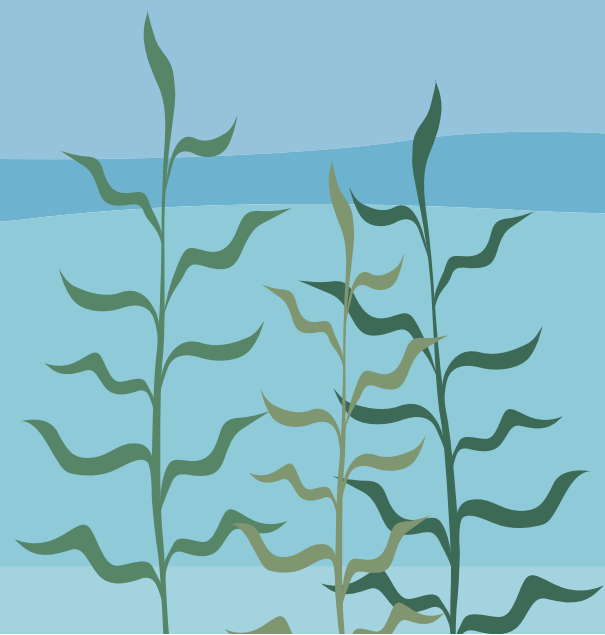



## ACKNOWLEDGMENTS

*This toolkit is inspired by British Columbia's Industry Training Authority's Youth Discover the Maker Way Program. The Taking Making into Classrooms Toolkit was created in collaboration with the University of British Columbia-Okanagan, Open School BC and the Industry Training Authority.*

*The original Maker Toolkit was developed with the goal of sparking more interest in trades amongst youth and to support educators in incorporating trades training and design thinking into the BC curriculum.*

*Additional thanks to Skills Canada Alberta (<http://www.skillsalberta.com/skills-exploration-days>).*

**We would also like to acknowledge Irving Shipbuilding who provided core funding for this project, as part of its Value Proposition commitment under Canada's National Shipbuilding Strategy**



Irving Shipbuilding, Inc.



Photo: Skills in Oceans Workshop  
Skills Canada Nova Scotia

## Creative Commons Licensing

Each toolkit is shared under Creative Commons Licensing in the hopes you will use the materials and share them with your friends and colleagues. However, when you have made modifications and changes to the original content, please attribute the original ownership of the materials.

Attributed to: *Taking Making into Classrooms: Ocean Toolkit* by Dr. Sherry Scully and Anna Naylor, Centre for Ocean Ventures and Entrepreneurship, is licensed under a Creative Commons Attribution-NonCommercial-ShareAlike 4.0 International License.

*Taking Making into Classrooms* by Dr. Susan Crichton and Deb Carter, Candidate for PhD, is licensed under a Creative Commons Attribution-NonCommercial-ShareAlike 4.0 International License.

CC licensing information: [http://creativecommons.org/licenses/by-nc-sa/4.0/deed.en\\_CA](http://creativecommons.org/licenses/by-nc-sa/4.0/deed.en_CA)

Based on a work at <http://innovativelearningcentre.ca/maker-days/> and <http://innovativelearningcentre.ca/thinking/careproject-page/>

# TAKING MAKING INTO CLASSROOMS

## A TOOLKIT FOR FOSTERING OCEAN LITERACY AND STEWARDSHIP

### Welcome

Since 2013, colleagues associated with the Innovative Learning Centre (ILC, <http://innovativelearningcentre.ca/>) have been pleased to provide toolkits on a range of topics. *Taking Making into Classrooms: Ocean Toolkit* is the sixth toolkit in this series.

### Summary of Ocean Toolkit

During the summer of 2018, we assembled a group of 50+ educators from across the province of Nova Scotia for our first 'Taking Making into the Classroom: Ocean Curriculum Participatory Design Conference'. This three-day experiential learning event provided an introduction to, and reinforcement of, the principles and practices of the Maker pedagogy, and connected STEM education in the k-12 system with 5 emerging ocean industries that are driving sustainable economic development across the maritime region. The workshop culminated in a participatory design session related to developing practical ocean-oriented maker-space programming with clear curricular links that teachers could use in their day-to-day practice. Central to this work, was an intention to integrate creative learning across the full STEM category, and also integrate ecological with economic principles. This is the foundation of the Blue Economy.

This Ocean Toolkit has been assembled from the hard work and collaboration inspired by the 50+ educators who participated in our Ocean conference and through support and partnerships with Dr. Susan Crichton, Innovative Learning Centre, UBC, Kelowna Campus, along with the Nova Scotia Department of Education and Early Childhood Development, the Marine People

Partnership operating through the Centre for Ocean Ventures and Entrepreneurship ([www.coveocean.com](http://www.coveocean.com)), and with financial support from Irving Shipbuilding Inc.

We encourage teachers to use and share this resource, add to it, modify it to suit older/young grades, or adapt it to extracurricular groups and clubs.

There is just one ocean that we all share, and the more we know and the deeper we understand, the more we will care about how we use and treat this precious resource that defines our great blue planet!



### Overview of Other Toolkits

Common to all the Innovative Learning Centre (ILC) toolkits is a belief that individuals can learn with an open process that supports design thinking, tinkering, and purposeful play. Our goal is to assist educators and community members as they take up and implement cross-curricular learning initiatives that are grounded in experiential, constructionist approaches.



1. Maker Day Toolkit V2 (<https://issuu.com/ubcedo/docs/makerdaytoolkitver2revisemay31e>) forms the foundation for Taking Making into Schools, the research-informed immersive professional learning (RIPL) events. The purpose of these events has been to help educators and community organizers facilitate new ways of engaging their constituent groups in sustained, effective and efficient professional learning. As of August 2016, these events have been offered to over 3,000 educators globally. Since its launch in 2013, the Maker Day Toolkit is available in print, ePub, and PDF formats. Thanks to funding from the Industry Training Authority of British Columbia (ITA BC), the Maker Day Toolkit has a series of videos that help to unpack the content in the toolkit. Additional videos are available that share experiences from various Maker Day events (ITA Maker Day 2013, Maker Day at Okanagan College, ITA Maker Day Sicamous).
2. The unConference Toolkit ([issuu.com/ubcedo/docs/unconferencetoolkitaug27e](https://issuu.com/ubcedo/docs/unconferencetoolkitaug27e)) was developed with in collaboration with the Digital Opportunity Trust ([www.dotrust.org/](http://www.dotrust.org/)). As a Canadian-based NGO, DOT operates economic, education, and leadership programs globally and develops the capacity of youth to become agents of change. Based on the central belief of youth empowerment, we believed the very structure of conferences and seminars needed to be reimaged. This reimaging enables the voice and active engagement of the most marginalized and novice participants, regardless of race, gender, religion, ability, and/or culture. The unConference Toolkit provides facilitation tips and shares conference structures with documentation proceedings using graphic recording. This toolkit is available as an ePub or downloadable PDF.
3. The Toolkit for Challenging Contexts ([https://issuu.com/ubcedo/docs/toolkit4cc\\_english](https://issuu.com/ubcedo/docs/toolkit4cc_english) and [https://issuu.com/ubcedo/docs/toolkit4cc\\_kiswahili](https://issuu.com/ubcedo/docs/toolkit4cc_kiswahili)) was developed in collaboration with Dr. Lilian Vikiru, formerly with Aga Khan University, Institute of Educational Development (AKU, IED), and teachers in rural Tanzania. The toolkit situates making within the context of rural schools in challenging contexts—schools with few or no education resources, access to the Internet, or stable electricity. The toolkit provides an introduction to making, active student learning, and professional learning. It forms the basis for a new program being offered by AKU, IED for primary educators and is available in print and as an ePub, in both English and Kiswahili, the official language of much of East Africa. This toolkit was funded as part of a Canada-Africa Reaching Exchange Grant (CAREG).
4. The Coding and Microcontrollers in Design Thinking Toolkit was developed by Maria Royston and Bill Latta. Completed January 2016, it is available as an ePub ([https://issuu.com/ubcedo/docs/diy\\_guidebook](https://issuu.com/ubcedo/docs/diy_guidebook)) and builds on the first Appropriate Technologies Maker Day co-facilitated by Women in Trades Training at Okanagan College ([http://www.okanagan.bc.ca/Programs/Areas\\_of\\_Study/trades/wtti.html](http://www.okanagan.bc.ca/Programs/Areas_of_Study/trades/wtti.html)). This toolkit introduces users to the world of simple microprocessing and coding without relying on expensive recipe driven kits.
5. Building on the ideas developed for the first Maker Day Toolkits, Taking Making into Classrooms: A Toolkit for Fostering Curiosity and Imagination was developed in response to classroom teachers who want to know more about introducing making to their students. Two versions were created to assist teachers design and develop classroom learning opportunities.

5.1 Taking Making into Classrooms: A Toolkit for Fostering Curiosity and Imagination which draws from the British Columbia Applied Design, Skills and Technologies (ADST) framework. This toolkit has companion courses for credit or noncredit self study.

5.2 Taking Making into Classrooms: Fostering Curiosity and Imagination in Alberta Classrooms which integrates classroom learning activities with a learn-a-skill event sponsored by Skills Canada Alberta and draws from the Alberta Career and Technology Foundations (CTF) program.

6. Taking Making into Classrooms: Ocean Toolkit was developed in collaboration with educators from the province of Nova Scotia, the Nova Scotia Department of Education and Early Childhood Education, and the Marine People Partnership operating through COVE (the Centre for Ocean Ventures and Entrepreneurship). Core funding for the development of this resource was received from Irving Shipbuilding as part of its Value Proposition commitment under the Canadian National Shipbuilding Strategy.

A full electronic copy of this toolkit is available through the COVE and Royal Roads websites;

<https://coveocean.com/projects/marine-people-partnership>

<https://commons.royalroads.ca/takingmaking/>

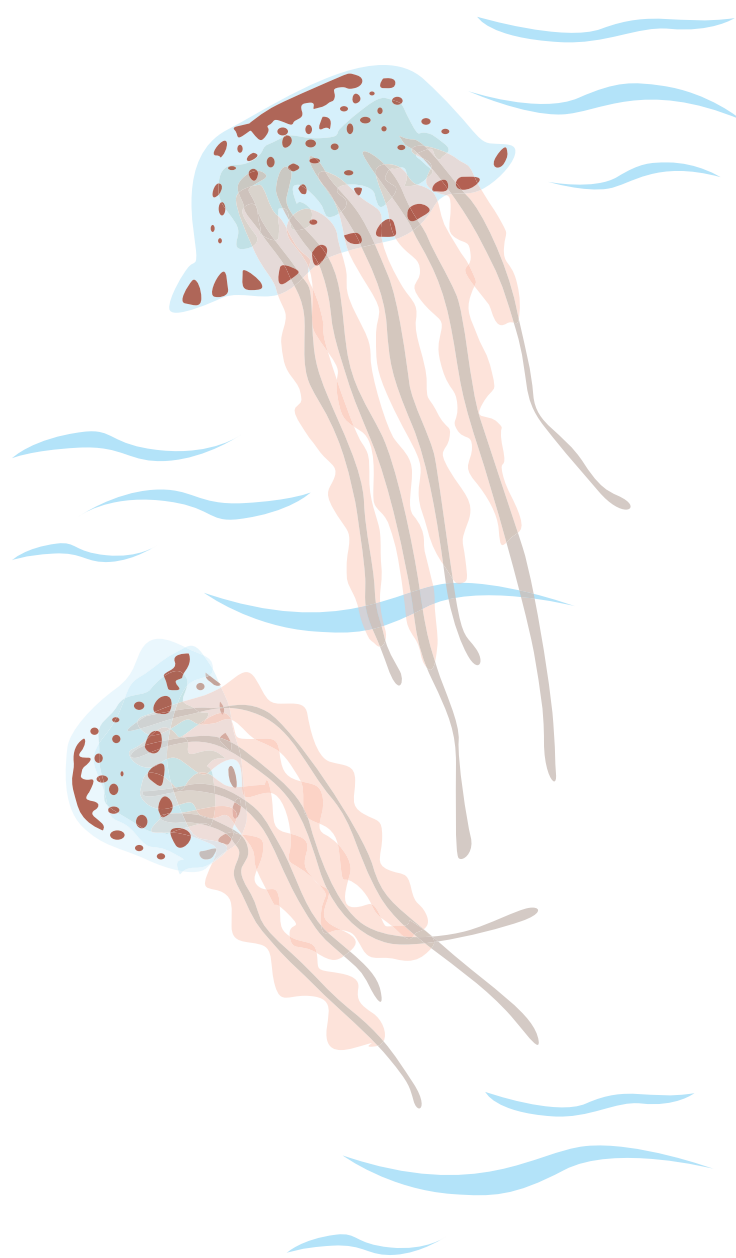

# THE MAKER MOVEMENT AND ITS PLACE IN NORTH AMERICAN LIVES

## Introduction

The Maker Movement allows us to celebrate the best gifts of humanity—the ability to think wisely, tinker creatively, and share generously. The maker movement is often described as an “umbrella term for independent inventors, designers and tinkerers. A convergence of computer hackers and traditional artisans, the niche is established enough to have its own magazine, *Make*, as well as hands-on Maker Faires that are catnip for DIYers who used to toil in solitude. Makers tap into an American admiration for self-reliance and combine that with open-source learning, contemporary design and powerful personal technology like 3D printers.

The creations, born in cluttered local workshops and bedroom offices, stir the imaginations of consumers numbed by generic, mass-produced, made-in-China merchandise.” (ADWEEK, March 17, 2014)

We prefer to think of the Maker Movement as an artisan social movement fueled by a fundamental human need to use, “our hands and imaginations together to make things and then make those things better,” (Hatch, 2014). These makers are empowered by open source technologies and virtually unrestricted access to information through the Internet.

Now more than ever before, North Americans are coming together in makerspaces. Whether in schools, libraries, or community centres, makers marry the notions of art, craft, design, innovation and entrepreneurship. In makerspaces, makers create a collective experience by sharing ideas, traditional/digital tools, and expertise to make things and tinker with ideas and resources. While they might seem to be a new phenomenon, makers have deep historical, cultural, and social roots in North American society.



Photo: Skills in Oceans Workshop  
Skills Canada Nova Scotia



## Cultural Roots

The maker culture emphasizes “informal, networked, peer-led, and shared learning that is typically motivated by fun and self-fulfillment” (Maker Culture, chapter in *Innovating Pedagogy 2013*, p. 34 The Open University. Retrieved 2014-01-09). As Wikipedia notes “*the maker culture encourages novel applications of technologies, and the exploration of intersections between traditionally separate domains and ways of working including metal-working, calligraphy, film making, and computer programming,*” ([https://en.wikipedia.org/wiki/maker\\_culture](https://en.wikipedia.org/wiki/maker_culture)). We view making on a continuum from personal enjoyment to marketable items; making can range from a lifestyle and a hobby to a way of community building to industry sponsored innovation.

## Social Roots

We are increasingly engaging in an interdependent and globalized economy. The rise of opportunities such as Airbnb, Car2go, community gardens, etc. suggests a shift to collaborative consumption and shared ownership, which confirms the need for makerspaces to support making. As Morozov (January 13, 2014) suggests, “*digital natives are starting to hunger for life beyond the screen. Making something that starts virtual but quickly becomes tactile and usable in the everyday world is satisfying in a way that pure pixels are not.*”

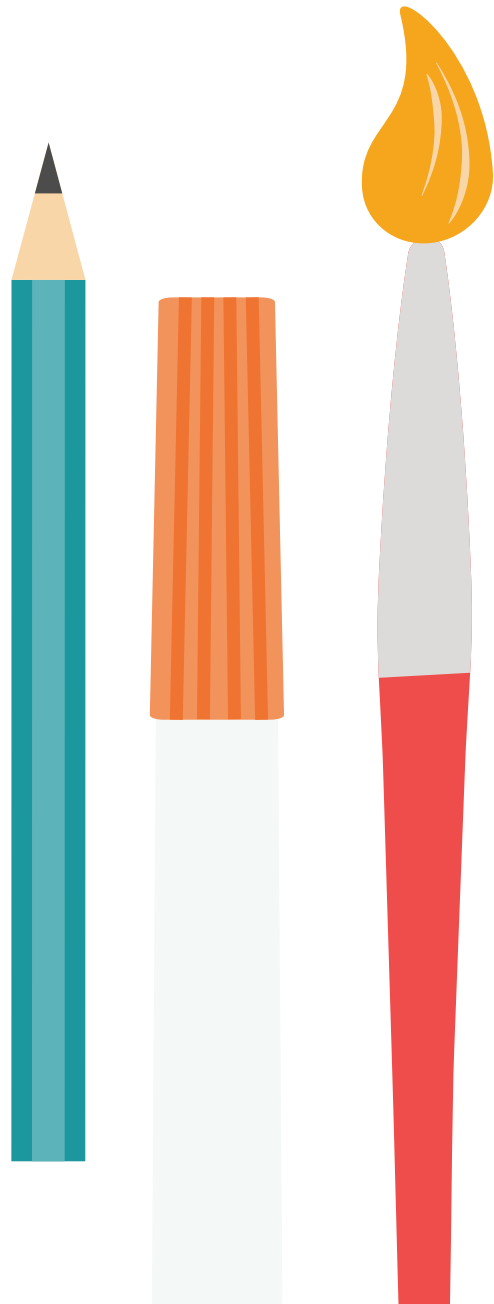



## Work Roots

Hatch (2014) suggests we are actually entering a new industrial revolution as we embrace the changes brought by our current Conceptual Age. If the first industrial revolution was powered by steam and the second by electricity, our new age is powered by unlimited access to information through the Internet. With this ubiquity and interconnectivity comes the rapid development of reasonably priced, powerful tools, as well as the ability to obtain a range of globally sourced materials with which to make things and then make those things better. Recognizing the Maker Movement has steadily evolved, Hatch describes the current Maker Movement as an “Internet of Physical Things” (p. 3). He claims the Maker Movement is actually bigger than the Internet because it includes physical objects connected via sensors to the Internet. The Internet of Things is a simple concept that is enabled by seemingly endless possibilities and options (<http://postscapes.com/internet-of-things-examples/>). Imagine adding components and additional functionality to the most ordinary, everyday objects. For example, what if we added sensors to road surfaces so they could tell drivers if the highway is slippery—we can! What if the cap of your pill bottle glowed when you had forgotten to take your daily dose—it can (<http://www.vitality.net/>). What if you could determine your physical activity during a day and track it in relation to your heart rate—you can with wearable fitness trackers

(i.e. *FitBit* or many others). The Internet of Things (IoT) requires us to think differently and to consider real problems as complex and multiple faceted. Once we begin to think beyond simple solutions, we can begin to add value, functionality, and combine amazing ideas together to create human centred, empathic responses to vexing situations. However, a willingness to be passionately curious is central to creative ideas. For those of you new to IoT, here are seven things to know (<https://library.educause.edu/resources/2014/10/7-things-you-should-know-about-the-internet-of-things>).

Supporting our current industrial revolution and the Internet of Things is “the largest untapped human resource on the planet... the space time, creativity, and disposable income of the creative class,” (Hatch, p. 52). Richard Florida, in *The Rise of the Creative Class*, suggests the creative class is an “amalgamation of engineers, artists, lawyers, programmers, designers, and others who have the educational or professional propensity to create,” (Hatch, p. 52). This class is fostering the majority of contemporary innovation and is moving into advanced manufacturing, which in turn is supporting an economic recovery, new employment options, and the rapid growth of the Maker Movement.



## HOW YOU MIGHT...

### ...Open a Conversation About Universal Design

When we talk about assistive tools and technologies, it is important to remember that there are universal principles that guide design. Design is typically defined as the capacity to plan and produce desired outcomes that meet human needs. Universal design is the capacity to design outcomes that meet the needs of “extreme users” (Bruce Mau, cited in Berger, 2009, p. 114), who are users in the most challenging of conditions or situations. The interesting thing is that the general user often benefits from the design as well. A good example of universal design are the curb cuts on sidewalks that have become commonplace in North America. Originally intended for enhanced wheelchair access to sidewalks, people pushing strollers, skateboarders, and bike riders have also benefited.

A great example of universal design in product design are the OXO Good Grips (<https://www.oxo.com/ourroots>). The story goes that Sam Farber was watching his wife struggle to peel carrots because of the increasing arthritis in her hands. He started observing the ergonomics and usability of existing peelers and started asking important questions, such as:

- How does the existing design and form affect us?
- How might the design/form be different?
- How might the change in design matter?

The result of Farber’s observation about carrot peeling resulted in a hugely successful product line—OXO Good Grips. It took multiple attempts, shapes, and adaptations (e.g. addition of ridges to the grips, more squeezable fins in the rubber, a better shape), but a better grip benefits us all!

Using the principles of universal design, identify instances of good design in your everyday items, classroom furnishings, or school environment.

An example of an individual turning a hobby into a social enterprise is Favio Chavez, an environmental technician in Paraguay who made trash into musical instruments for the impoverished children in his community. Please read the full story and hear the results of the project at <http://www.cbsnews.com/news/the-recyclers-from-trash-comes-triumph/>.

Another example of a company using good design to address a social issue is the story of the 15 Below Jacket Project. TAXI, a small company whose mantra is “Doubt the Conventional,” decided it wanted to give back to its community on its 15th anniversary by attempting to address homelessness. The result was the development of the 15 Below Jacket. Please check out their website for details (<http://agency.taxi/work/client/taxi-the-15-below-project/>).

These examples are only a few among the many that we offer to illustrate the scope / range of making activities. The scope and range of activities illustrated in Table 1-1 is consistent with the K–12 curriculum in the Applied Design, Skills and Technologies framework.



**TABLE 1-1: Scope and Range of Maker Activities**

Zero to Maker	Maker to Maker	Maker to Market
<ul style="list-style-type: none"> <li>• Inspiration to invent</li> <li>• From consumer to having a hand in making</li> </ul>	<ul style="list-style-type: none"> <li>• Collaboration &amp; access to the expertise of others</li> <li>• Need to unleash the innate desire for self-expression &amp; creation</li> </ul>	<ul style="list-style-type: none"> <li>• Invention &amp; Innovation</li> <li>• Knowledge flows and concentrates</li> </ul>
Skills Needed		
<ul style="list-style-type: none"> <li>• Ability to learn &amp; access to means of production</li> </ul>	<ul style="list-style-type: none"> <li>• Desire to improve and share with others</li> </ul>	<ul style="list-style-type: none"> <li>• Capacity to scale</li> <li>• Appeals to market beyond self, family, &amp; friends</li> </ul>



Photo: Skills in Oceans Workshop  
Skills Canada Nova Scotia



# MAKING THE CONNECTION: DESIGNING, MAKING, AND A NEW CULTURE OF LEARNING

## Introduction

Locally and globally, from Ministries of Education to non-governmental organizations (NGOs) like UNESCO, educators recognize the need to make learning more authentic, engaging, and experiential. We know the maker movement has a significant role to play in these educational reforms. *Taking Making into Classrooms: Ocean Toolkit* fosters curiosity, imagination, and active learning. It aligns beautifully with new curriculum initiatives.

Teachers have often commented to us that they want to introduce design thinking and making into their classes and classrooms. They felt they lacked the language to advocate for it and struggled to find the academic fit for making within an already overcrowded curriculum. The intent of this section is to help with both concerns. Making is a pedagogical orientation as well as subject for study.

## Pedagogical Orientation

Our research and experience tells us that Papert (1980) was right—when we give children powerful tools to think with, there is no limit to learning! All too often we ask too little of our students and give them too little time to uncover all the exciting things there are to explore and learn. As a pedagogical orientation, the roots of making can be found in John Dewey's call for experiential learning. In his book *The School and Society*, Dewey (1899) suggests that every school must support "an embryonic community life, active with types of occupations that reflect the life of the larger society and permeated throughout with the spirit of art, history and science. When the school introduces and trains each child of society into membership within such a little community, saturating [a student] with the spirit of service, and providing [a student] with instruments of effective self-direction, we shall have the deepest and best guarantee of a larger society which is worthy, lovely and harmonious," (p. 44). By taking making into their classrooms, teachers draw upon a rich, research-informed literature of constructionist learning, dating from Dewey to Papert to contemporary work out of the Lifelong Kindergarten group at MIT (<https://llk.media.mit.edu/>).

Papert's theory of constructionism states that the best way to construct knowledge and understanding is through the construction of something that is shareable outside of the student's head (Papert & Harel, 1991). Papert suggests that by using creative and critical thinking, students can work collaboratively to explore materials, use tools and equipment, design, build, develop processes, and communicate the merits of their work in unique and exciting ways. The Lifelong Kindergarten group at MIT continues Papert's work and, among other things, developed SCRATCH—the object oriented programming software for children (<https://llk.media.mit.edu/>).



## New Culture of Learning

Contemporary research from Stanford University suggests that when we tinker with complicated and engaging tasks, make mistakes, and encounter failure, we do the intellectual wrestling that fosters the development of brain synapses, which build brain plasticity and intelligence. Jo Boaler, in her work with students to build mathematical understanding, has learned that effort and practice grow the essential brain plasticity that supports

deep learning. You can explore her work at <http://www.youcubed.org/> and <https://www.youcubed.org/think-it-up/mistakes-grow-brain/>.

A growth mindset differs from the more traditional idea of a fixed mindset. A fixed mindset suggests there are things that we can and cannot do well. A growth mindset suggests we can grow our capacities by wrestling with problems worth thinking about and by continually learning.

**TABLE 1-2: Two Mindsets**

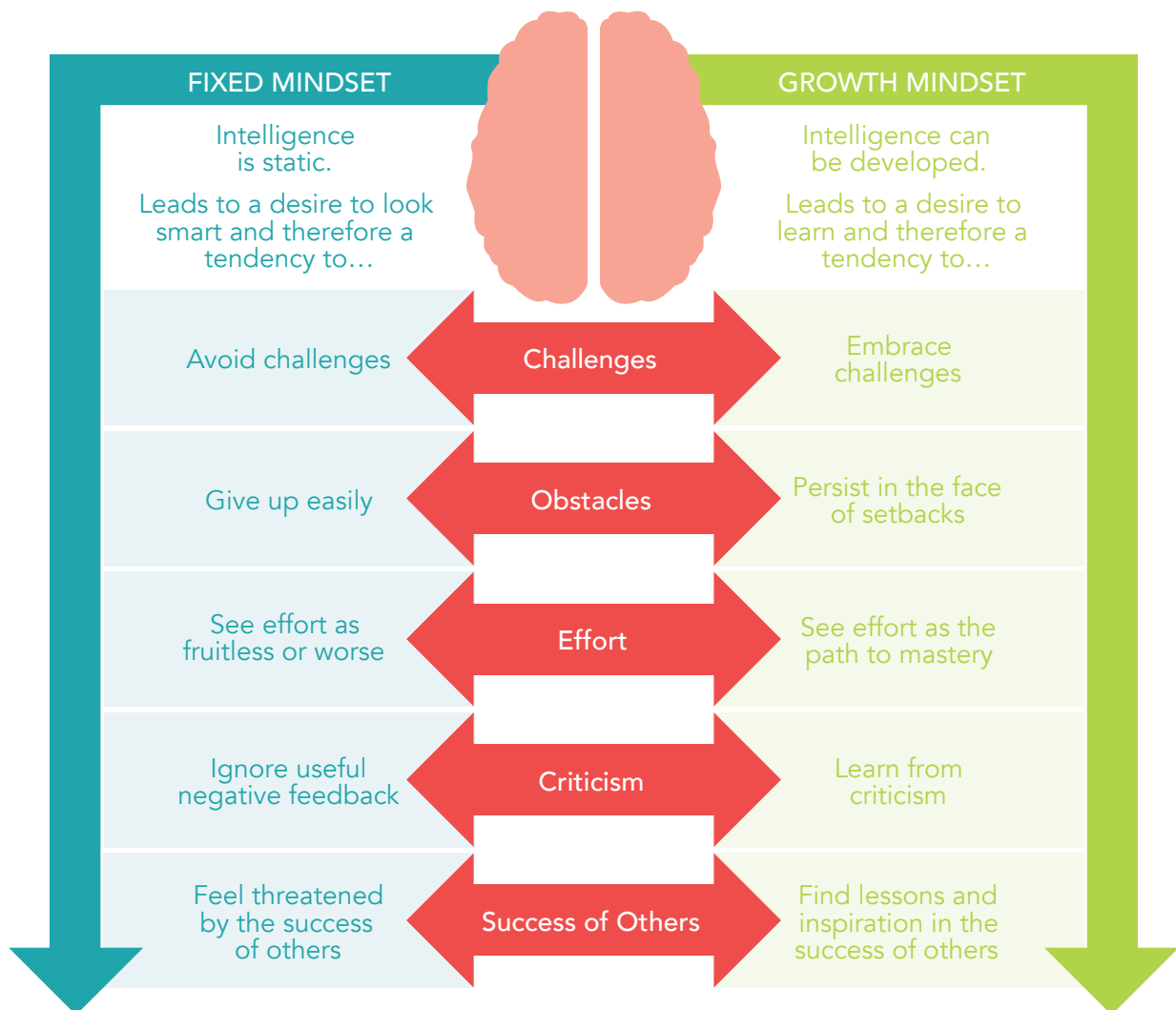

As a result, they may plateau early and achieve less than their full potential. This confirms a deterministic view of the world.

As a result, they reach ever-higher levels of achievement. This confirms a greater sense of free will.

Carol Dweck researches the notion of a growth mindset and her TED Talk explores how “we can grow our brain’s capacity to learn and to solve problems,” ([https://www.ted.com/talks/carol\\_dweck\\_the\\_power\\_of\\_believing\\_that\\_you\\_can\\_improve?language=en](https://www.ted.com/talks/carol_dweck_the_power_of_believing_that_you_can_improve?language=en)). In her TED Talk, Dweck mentions a school in Chicago that did not issue failing grades for students; rather, it recorded the grade as “not yet.” This assessment suggests students may achieve success in time and with more learning. As Popova (2014) describes:

*“At the heart of Dweck’s research, and what makes the ‘growth mindset’ so winsome, is a student’s passion for learning rather than a hunger for approval. Its hallmark is the conviction that human qualities like intelligence and creativity, and even relational capacities like love and friendship, can be cultivated through effort and deliberate practice. Not only are people with this mindset not discouraged by failure, but they don’t actually see themselves as failing in most situations—they see opportunities for learning,”* (par. 4, <https://www.brainpickings.org/2014/01/29/carol-dweckmindset/>).

Neural plasticity and growth mindsets align with Yong Zhao’s message concerning 21<sup>st</sup> century learning: we must support uniqueness, foster creativity, and support entrepreneurial thinking. To do this, Yong Zhao and others say that schools must create more time for students to explore and engage in purposeful play in order for them to build confidence in their ability to learn and find their passions.

Developing a growth mindset, fostering creativity, and engaging in design thinking are all components of a pedagogy of promise: one that is optimistic, seeks the good in situations, and encourages the positive development of individual capabilities. The International Society for Technology in Education (ISTE) recently revised their skill and knowledge standards for digital age students (<http://www.iste.org/standards/standards/standards-for-students>), identifying seven skill and knowledge areas.

Making enables the type of learning environment suggested by the OECD (*Organization for Economic Co-operation and Development*), an international organization founded to stimulate economic progress and world trade. OECD suggests that learning environments must be:

- learner-centred,
- structured and well-designed,
- profoundly personalized,
- inclusive, and
- social.

These learning environments are consistent with the Conference Board of Canada’s call to provide learning experiences that are focused on developing

- creativity, problem-solving, and continuous improvement skills;
- risk assessment and risk-taking skills;
- relationship-building and communication skills; and
- implementation skills.

The core literacies required to fully participate in these new learning environments include what Trilling and Fadel (2009) identify as:

- critical and creative thinking,
- problem finding and problem solving,
- authentic learning, and
- collaboration.

Together, the alignment of a growth mindset with making in these types of learning environments helps teachers to come closer to Einstein’s description of education—*“It is not the learning of facts, but the training of the mind to think.”*

**TABLE 1-3: Fostering an Intentional Mindset**

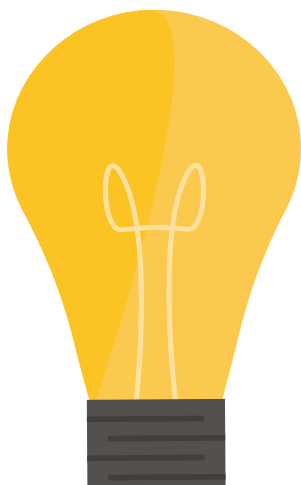
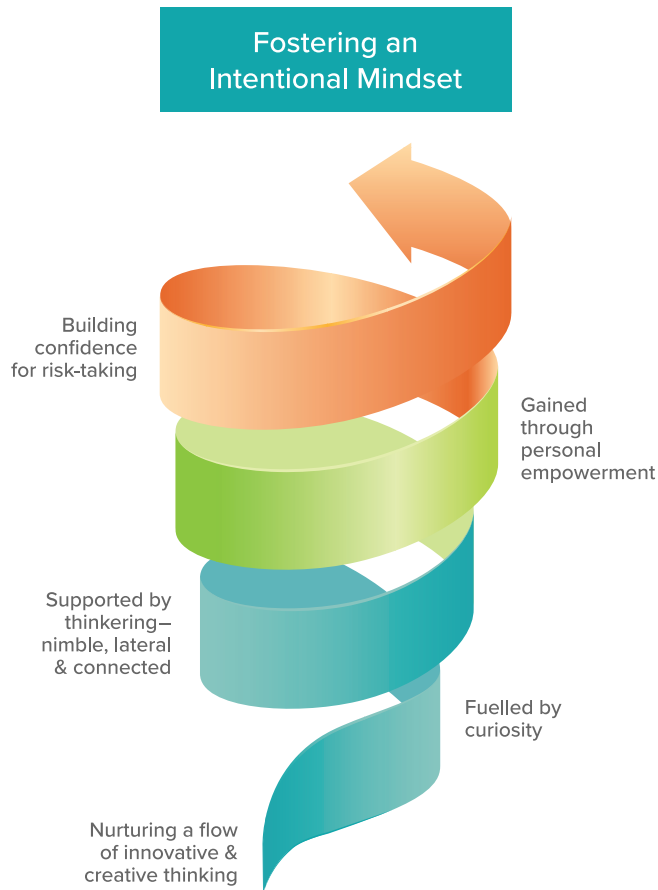

**HOW YOU MIGHT...**

**...Introduce Design Portfolios**

As part of your instructional and assessment strategies, ask your students to maintain their own design portfolios. Design portfolios can be a large envelope or 3-ring binder. Students can keep their design thinking worksheets in their design portfolios and use the portfolios to maintain ongoing sketches and sketch noting.

In terms of sketch noting, you might want to refer to the free download, Ditch That Textbook, for tips on sketch noting/graphic note taking (<http://ditchthattextbook.com/>).

A design portfolio allows you to support your students' growth through reflective, formative dialogue. Table 2-1 suggests ways in which you can foster growth through dialogue with and amongst your students. The table builds on the work of Schön (1987) and Svarovsky and D. W. Shaffer (2006).



**TABLE 1-4: Fostering Students' Growth through Reflection & Formative Dialogue**

	Description	Example of Opening Dialogue
Reflection-on-action	Comments made about students' actions/activities that have already taken place.	Great start on your thinking. Appreciated the details and descriptions of your sketches.
Reflection-in-action	Comments made about students' current actions/activities or plans that are about to take place or could take place in the future.	Good initial ideas. Wonder what your next steps will be? Who else might you consult with to improve your design idea?
Skill Development	Comments made about students' skill improvement, areas of strength, and areas needing growth.	Good use of perspective and detail in your sketches. Wondering if you have considered other ways of representing your thinking?
Knowledge	Comments made on students' domain expertise.	Excellent demonstration of your growing understanding hydraulics and how hydraulics can make your design more functional and efficient.
Values	Comments made probing students' aesthetics, beliefs and social justice.	Your design suggestion is a wonderful example of simplicity and function in addressing how a homeless person might keep their possessions dry and why that might be problem in the spring weather conditions.
Agency	Comments made about students' proactive thinking and personal problem finding efforts.	Excellent initiative in determining who to need to interview and why their point of view might be important to your design.

# DESIGN CHALLENGES: PROMPTS FOR LEARNING AND HARD FUN

## Introduction

Seymour Papert, the MIT educator and innovator who co-developed the computer program LOGO and the pedagogy of constructivism, coined the phrase “hard fun.” He came to this phrase after listening to students as they programmed their software turtles using his program LOGO. Students described their initial work as being fun and hard—hence “hard fun.” Please see <http://www.papert.org/articles/HardFun.html> for details. *Taking Making into Classrooms: Ocean Toolkit* should be hard fun; it should link learning, making and curriculum together in engaging ways.

Using makerspaces and participating in Making Faires<sup>1</sup> are also hard fun. They have a place and a value in our informal learning. However, while working in makerspaces and participating in Maker Faires may support curricular goals, the intentionality suggested on page 10 might be missing. Without an intentional mindset, making risks becoming just another event or an additional thing to fit into an already overcrowded curriculum. Our work suggests that through the creation of contextually relevant design challenges, teachers can take making into their classrooms in intentional, sustainable and meaningful ways.

Students can think about design challenges in two ways—first, as an act of design (the what) and second, in the choices of which skills (the how) and technologies (the help) assist in the process of making. As Papert (2005) stated, “*You can’t think about thinking without thinking about thinking about something.*” We suggest that it is hard to make something worth making without having a design challenge worth solving. Equally important is a process by which you engage in problem finding, inquiry, tinkering, thinking, and reflecting to develop a solution.

A design challenge positions making within a particular context, inviting students to

collaboratively engage in design thinking as a process to define the problem (*problem finding*) and to prototype solutions (*tinkering*). While design thinking is similar to the scientific method, it differs significantly in terms of its focus on empathy and human-centred concerns. For more on the similarities and differences between the design process and the scientific method, please read <http://renovatedlearning.com/2016/02/08/teaching-thedesign-process/>.

The design thinking process used in *Taking Making Into Classrooms* modifies the five step approach honed at Stanford’s d.School into four phases (*design, tinker, thinker, reflect*). It consists of five activities (*design challenge, human-centred design thinking process, collaborative prototyping, design charrette, individual/group reflection*), which will be described in this toolkit.

Design challenges support inquiry and problem-based learning. When inquiry and problem based learning are supported by making through a design thinking process, teachers have the potential to encourage problem finding. Teachers can invite students to locate relevant and just in time information while tinkering with ideas, concepts, materials, and information as they prototype a possible solution.

---

<sup>1</sup> Examples include <http://makerfaire.com/>; <http://ets.educ.ubc.ca/ubccentennial-maker-faire/>



## Deepen Your Understanding

Our experience suggests there are three primary ways to structure a design challenge.

1. As an inquiry question
2. As a problem to be solved
3. As a scenario to play out

Inquiry questions encourage exploration and engagement with curricular topics. For an example of inquiry based learning in mathematics, please explore the site Looking at Math as Inquiry <http://karimkai.com/on-purpose/>.

Problem solving is *“cognitive processing directed at achieving a goal when no solution method is obvious to the problem solver,”* (Mayer & Wittrock, 2006, p. 287).

They explain learners need five kinds of knowledge to be successful problem solvers:

- Facts: knowledge about characteristics of elements or events;
- Concepts: knowledge of a categories, principles, or models, such as knowing what place value means in arithmetic or how hot air rises in science;
- Strategies: knowledge of general methods, such as how to break a problem into parts or how to find a related problem;
- Procedures: knowledge of specific procedures, such as how to carry out long division or how to change words from singular to plural form; and
- Beliefs: cognitions about one’s problem-solving competence (such as *“I am not good in math”*) or about the nature of problem solving (e.g., *“If someone can’t solve a problem right away, the person never will be able to solve it”*).

Problem-based learning (PBL) is a student centred approach that positions learning in the form of open questions. Students typically work in groups and are encouraged to share what they already know, pose questions about what they need to know, engage in research, and form a theory or series of ideas about what they have learned. PBL can be used to support making as students can make their learning visible in tangible demonstrations of learning. Please check out the Edutopia resources on PBL available from <http://www.edutopia.org/video/5-keys-rigorousproject-based-learning>.

Scenarios provide information and context in the form of a story or narrative. The purpose of a scenario is to set the scene for a project, introduce learners to a project, and to create a common starting point. A scenario can also set the parameters for the project, outline any limiting factors, special conditions, and time/context constraints. Scenarios are creative ways of imagining a “different future” or an alternative way of doing something. They help the learners visualize the context for the task as they usually cover environmental, social, technical, political, and economic concerns.

## Structure of a Design Challenge

We often use scenarios to invite students into the design challenge. Scenarios help students to visualize the context in which the inquiry or problem is situated by creating a story or narrative for student engagement with the challenge.

We have learned there is a simple elegance to drafting a good design challenge. Building on Papert's idea of hard fun, we think a design challenge needs to be open enough to invite multiple perspectives, insights and solutions while structured enough to provide support and initial direction. Design challenges bridge prior learning so existing curriculum, content, and contexts can be situated within challenge components.

Table 1-5 describes the parts of our design challenge format. Curriculum links can be introduced in the Overview and Design Rationale. How students are to engage with the challenge can be positioned with the Problem Scenario. Assessment can be explained in the Success Determinants section, while the Parameters section can be used to scope the learning activities within the possibilities of a specific classroom learning environment (*i.e. access to tools, resources, materials, etc.*).

**TABLE 1-5: Design Challenge Components and Descriptions**

Design Challenge Component	Component Description
Overview	Introduction to the challenge to provide an authentic learning context or situation.
Design Rationale	Short explanation of why the challenge is in fact a challenge worth addressing and links students' prior learning while also providing links to new information.  Resources and sources to guide initial inquiry work can be positioned here.
Problem Scenario	Paragraph inviting participants into the challenge and explaining the role/reason for their group's involvement in addressing the problem.
Success Determinants	Usually begins with "Success will be determined by the degree to which your design solution:" followed by criteria for assessment using suggested characteristics/attributes that constitute a good design solution for the challenge.
Parameters	Specific issues, constraints or limiting factors impacting the participants, which should be addressed ( <i>i.e. rules, limitations</i> ) for the group to negotiate.



A well-crafted design challenge fosters heads-in (*content*); hearts-among (*empathy, curiosity and purpose*); hands-on (*skill sets*) and creates rich, multidimensional/multimodal/multimedia opportunities for students to demonstrate what they know and how they came to know it in deep and personal ways.

For example, Designing a Healthy Lunch Experience works well because it positions making in the aid of a complex problem: why the majority of people do not get adequate nutrition during the workday. It might even begin to address the wicked problem of affordable food, childhood obesity, and wellness.

## Complex and Wicked Problems

**Complex problems** are challenges without an easy or obvious solution. The site Mathalicious shares rich and engaging examples of complex problems positioned with math (<http://www.mathalicious.com>). This site approaches math as a subject for inquiry and problem-based learning, reminding teachers that when they give students too much information (*just-in-case learning*), the task for students becomes merely finding the correct answer.

*"If you ask teachers to define the purpose of math class, I suspect many would say something along the lines of, 'To help students become better problem solvers.' As a community, we seem to equate learning math with solving problems, where the goal is to illustrate some underlying mathematical concept: proportionality, linearity, etc. Unfortunately, the tasks we've traditionally relied on for this are often so forced as to be caricatures of themselves.*

*Confronted with problems like these, students frequently ask of math, 'When will I ever use this?' Yet as many teachers have pointed out, this may not be their real question. Instead, 'When will I use this?' may be code for, 'I don't get this and I feel dumb.' Traditional tasks often reveal so much information on the front-end that students interpret their responsibility as to calculate an answer rather than to engage in a problem-solving process,"*

([http://karimkai.com/on-purpose/?utm\\_source=EdsurgeTeachers&utm\\_campaign=096643cdc9-Instruct+215&utm\\_medium=email&utm\\_term=0\\_3d103d3ffb-096643cdc9-292150001](http://karimkai.com/on-purpose/?utm_source=EdsurgeTeachers&utm_campaign=096643cdc9-Instruct+215&utm_medium=email&utm_term=0_3d103d3ffb-096643cdc9-292150001)).

Inquiry and problem-based learning, supported by design thinking and making, encourage problem finding, locating relevant and just-in-time information, and tinkering with ideas, concepts, materials and information in order to prototype a possible solution. You might want to explore the inquiry based learning resources available from [http://www.learnalberta.ca/content/kes/pdf/or\\_ws\\_tea\\_inst\\_02\\_inqbased.pdf](http://www.learnalberta.ca/content/kes/pdf/or_ws_tea_inst_02_inqbased.pdf) and <http://www.teachingbooks.net/content/FocusOnInquiry.pdf>.

**Wicked problems** are defined as social, cultural or environmental problems that appear impossible to solve because:

- there is incomplete or contradictory knowledge about the problem itself;
- the number of people and opinions involved and the potential large economic burden add additional layers of complexity; and
- the actual problem is interconnected with other problems ([https://www.wickedproblems.com/1\\_wicked\\_problems.php](https://www.wickedproblems.com/1_wicked_problems.php)).

Wicked problems include issues such as global warming, poverty, homelessness, equality, and health and wellness. Horst Rittel (1973) identifies ten characteristics of wicked problems:

1. Wicked problems have no definitive formulation. For example, poverty in North America is different from poverty global south.
2. It's hard, maybe impossible, to measure or claim success with wicked problems because they bleed into one another, unlike the boundaries of traditional design problems that can be articulated or defined.
3. Solutions to wicked problems can be only good or bad, not true or false. There is no idealized end state to arrive at, and so approaches to wicked problems should be tractable ways to improve a situation rather than solve it.
4. There is no template to follow when tackling a wicked problem, although history may provide a guide. Teams that approach wicked problems must literally make things up as they go along.
5. There is always more than one explanation for a wicked problem, with the appropriateness of the explanation depending greatly on the individual perspective of the designer.
6. Every wicked problem is a symptom of another problem. The interconnected quality of socioeconomic political systems illustrates how, for example, a change in education will cause new behavior in nutrition.
7. No mitigation strategy for a wicked problem has a definitive scientific test because humans invented wicked problems and science exists to understand natural phenomena.
8. Offering a "solution" to a wicked problem frequently is a "one shot" design effort because a significant intervention changes the design space enough to minimize the ability for trial and error.
9. Every wicked problem is unique.

10. Designers attempting to address a wicked problem must be fully responsible for their actions. Written at grade/content appropriate levels, wicked problems make an important starting place for design challenges because, by definition, the problems are ill-structured, complex, situational, and authentic. Complex and wicked problems require extended periods of time and effort to address them well, so both types of problems support a sustained investigation or inquiry.



## HOW YOU MIGHT...

### ...Introduce a School Wide Initiative

Consider ways in which you could create a complex or wicked problem that would be the focus for your school for an entire semester or school year. How might it focus fund raising, social justice initiatives, guest speakers, and community engagement activities for that time period?

### ...Develop an Inquiry-Based Unit of Study

Consider ways in which a complex or wicked problem could be the focus on inquiry within a classroom for a sustained period of time. Could a complex or wicked problem be the way to introduce a unit of study? Can you determine a curricular link to a big idea and develop a Design Challenge to help students uncover the deep, personal learning within the learning outcomes while gaining the required competencies?

### ...Explore Resources

Please explore [http://www.learnalberta.ca/content/kes/pdf/or\\_ws\\_tea\\_inst\\_02\\_inqbased.pdf](http://www.learnalberta.ca/content/kes/pdf/or_ws_tea_inst_02_inqbased.pdf) and <http://www.teachingbooks.net/content/FocusOnInquiry.pdf>.

# CRAFTING A DESIGN CHALLENGE

Crafting a design challenge is the same whether you start with a complex or wicked problem, a curricular objective, or a learning outcome. After years of using the structure in Table 3-1, we have found that each component included in the design challenge is essential and interrelated. You do not need to start writing the components in the order in which they will ultimately appear in the design challenge. Our experience tells us that as you write each component, the other components will need to be modified and edited to reflect your intent. The design challenges consist of the following components:

- Overview Statement provides the background for the challenge.
- Design Rationale provides the authentic context for why the challenge is important. It connects the actual challenge to the students' learning by situating it within class discussions or experiences.
- Problem Scenario invites students into the challenge and explains the groups' roles and reasons for involvement in addressing the challenge.
- Success Determinants provide the criteria for how the design solutions will be assessed or peer evaluated during the design charrette.
- Parameters set the rules and limitations to which groups have to adhere. Parameters explain the opportunities, constraints, rules, requirements to use the materials, resources, tools available during the challenge.

Tips on crafting each component follow.

## Overview

- Typically, the overview is very short and subtly positions the challenge within what the students already know (previous curriculum or field trips or shared experiences).
- The introduction makes the challenge real by situating it within current events, history, your community, etc.
- Depending on the literacy levels of the students, web links can be provided that link the challenge to existing content/resources. You might want to consider linking to or creating an accompanying WebQuest (<http://webquest.org/>) to focus the students inquiries and web searches. For example, please look at the teacher design WebQuest on Genetically Modified Crops (<http://webquestgmcrops.weebly.com/teachersnote.html>).

## Design Rationale

- In this section, new learning/content can be introduced.
- Again, a WebQuest, web links, or other resources can be added.
- If there are local experts you can invite into class or bring in via video/audio links, this is where you could list/name them. Local experts could be extremely valuable when you get into the design thinking process, as the students can interview them to gain further empathy and understanding of the challenge.

- Linking to Ted Ed (<http://ed.ted.com/>) and other sources of expertise on timely topics can enhance students' understand of the significance of the challenge in which they are engaging. For example, if your design challenge is focusing on Global Warming, you might incorporate Erin Eastwood's Ted Ed on wildlife adaption to climate change (<http://ed.ted.com/lessons/can-wildlife-adapt-to-climatechange-erin-eastwood>). The Ted Ed link provides content expertise and the "Discuss" link provides an interesting guided discussion question that could be shaped into a great inquiry question for the next component— Problem Scenario.

### Problem Scenario

Everyone loves a good story. Scenarios provide a narrative that helps students move from merely thinking about concepts in an abstract sense (theoretical knowledge) to feeling about the concepts and applying them in real or concrete applications. It helps students to shift from passively reading about/thinking about information to doing something with the information.

When passively learning, students typically respond to teacher questions by finding correct answers. When actively creating their own knowledge about complex things, students begin to form their own questions, and to recognize that learning is not merely about answers, it is about great questions. Einstein said it best: "Education is not the learning of facts, but the training of the mind to think."

### Success Determinants

- Design thinking and making engage students in a process that tends to lead to a product.
- Assessment of the process is as important as evaluation of the product.
- Consider informal, formative and summative forms of assessment, including self and peer assessments.

While the best design challenges will be the ones you write for your own students in your own classroom contexts, the Ocean Toolkit Modules offer a variety of design challenges that you might want to use with your students or to inform your design challenge development.

### Parameters

- Parameters set the ground rules for working within the challenge. For example, this section might tell students what they have to use or do to create common experience— i.e. students to have to use something of everything in a group kit provided for them, whereas they have the option to use things in a shared pantry of consumable items.
- Students should be directed to a Safety Station where they can be shown the proper way to use the tools and materials available during the challenge.

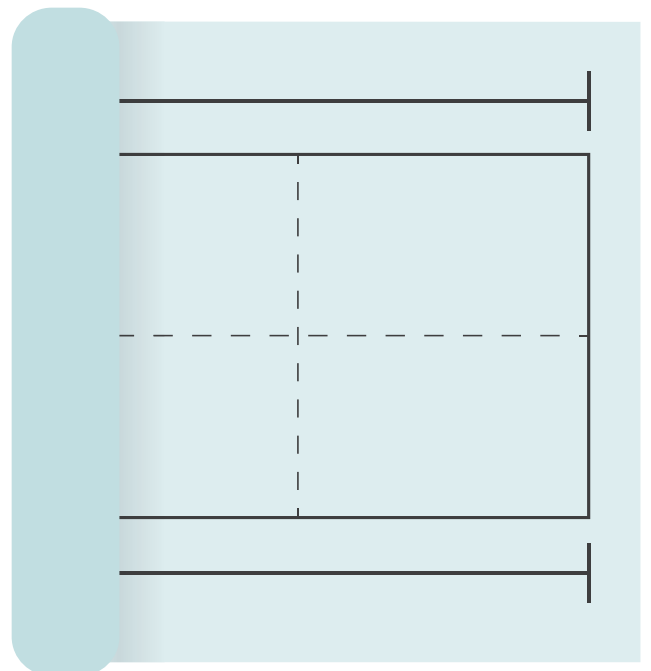



# ASSESSMENT: REIMAGINING WAYS TO VALUE PROCESS, PRODUCT, CREATIVITY, AND LEARNING

## Success Determinants within the Design Challenge Format

When you use a design challenge you will need to determine the type(s) of assessment you want to accomplish and what factors you will accept as evidence of student learning. By adopting a constructionist pedagogy and using an inquiry or problem-based learning instructional approach, you will be creating a more open, student centred learning environment. Therefore, identifying the success determinants in the design challenge is essential for fairness and transparency in assessment. For example, it would seem unfair to introduce students to the design thinking process, ask them to collect information, conduct research, create design notes and sketches and then only assess them on the final product of the process. Consider which of the following you might want to include as part of your assessment:

- Students' participation in the group design thinking process
- Students' understanding of key concepts positioned in the Overview and Design Rationale
- Students' understanding of specific content areas or curricular big ideas or competencies
- Students' understanding and abilities with developing skills and using appropriate technologies (tools)
- Students' ability to ask good questions and reflect on the process as well as their shared products
- Students' understanding of the challenge and the quality of the finished product
- Students' creativity and imagination
- Other aspects identified in lesson outcomes or curricular modules

## Assessment Tools

Success determinants for a design challenge can be spelled out in general terms for the students. As the teacher, you will probably want to develop an assessment tool that allows you to make a fair and equitable assessment of student learning that might be demonstrated in a variety of ways. Fair and equal are challenging concepts, and open ended, project based learning pushes teachers to think creatively about how to be fair and accountable to student learning.

There are a variety of assessment tools you might use. We suggest the following:

- Design Portfolio – see the How You Might... tip on page 11. A design portfolio allows you to support your students' growth through reflective, formative dialogue.
- Rubrics – used to assess performance along a continuum. We created a rubric using Rubistar (<http://rubistar.4teachers.org/index.php>).
- Checklists – used to record Yes/No observations of students' abilities against specific criteria. Criteria need to be written clearly and linked to specific learning outcomes, skills and abilities.
- Rating Scales – observations of students' abilities against specific criteria for assessment along a range—always, sometimes and never; or fair, good, excellent. Criteria need to be written clearly and linked to specific learning outcomes, skills, and abilities.
- Anecdotal Notes – teacher recorded observations that are typically informal, short, and describe a student's developing understanding and participation throughout a design challenge or inquiry unit. They focus on behaviours as well as skills and abilities.

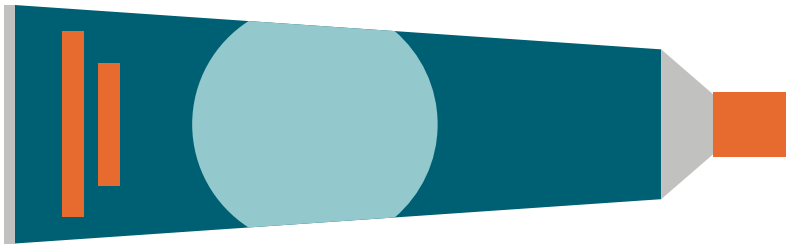

- Observation Checklists – allow teachers to make quick yes/no observations of what students can do, how they interact with others, and how they are progressing through the process of a design challenge.
- Portfolios – a purposeful compilation of design notes, sketches, digital documentation, and other evidence that students are asked to collect throughout the design challenge. Each element of the design challenge can generate items for inclusion on a portfolio.
- Peer Assessment – student peers can use checklists or rubrics to assess classmates' work on a design challenge.
- Self-Appraisal – students can use a framework to consider their own learning and achievement within or across specific or open learning outcomes.

For examples of rubrics to assess design thinking and development of empathy, please explore [https://dschool.stanford.edu/groups/k12/wiki/8d33d/Design\\_Thinking\\_Assessment.html](https://dschool.stanford.edu/groups/k12/wiki/8d33d/Design_Thinking_Assessment.html).

Teachers know that assessment practices are the tail that wags the pedagogical dog. If assessment stays the same (i.e. only summative or standardized examinations, etc.) then innovative ways of teaching and learning become lost in the battle over what counts as learning. Changes in assessment in British Columbia are going a long way to address this concern and the introduction of the Applied Design, Skills and Technologies framework and curriculum can help us to take making into the classroom in an intentional way.

As David Gooblar writes in his blog, “real learning comes from practice and from awareness of past missteps. When we don’t let students redo their graded work for credit, are we telling those students who did poorly that there’s no point in trying to learn from their mistakes?”

I see two main arguments here:

- The first is that we unfairly reward students who get it right the first time, while penalizing those students who need more time to learn what’s being tested.
- The second is that we discourage students from working to learn from their mistakes,” (2016, para. 6).

Wiggins and McTighe’s work on assessment within Understanding by Design offers support to teachers as they make substantial change to assessment.

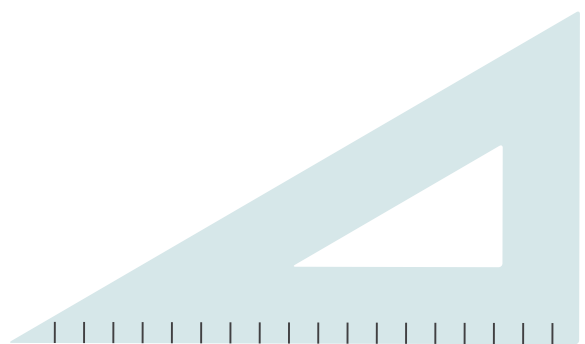

# HONOURING THE PARTS THAT MAKE THE PROCESS WHOLE

## Introduction

As explained, we have conceptualized a four-phase approach to *Taking Making into Classrooms: Ocean Toolkit*. Each part is critical in fostering the intentional mindset that embeds making within existing curriculum and embodies it in pedagogical orientation. As stated previously, the design thinking process used in *Taking Making Into Classrooms: Ocean Toolkit* modifies the five step approach honed at Stanford's d.School (Table 1-6).

By using a design challenge as a prompt and extending the amount of time for tinkering and thinking, students experience the four phase model shown in Table 1-7.

**Table 1-6: Stanford's d.School design thinking process**

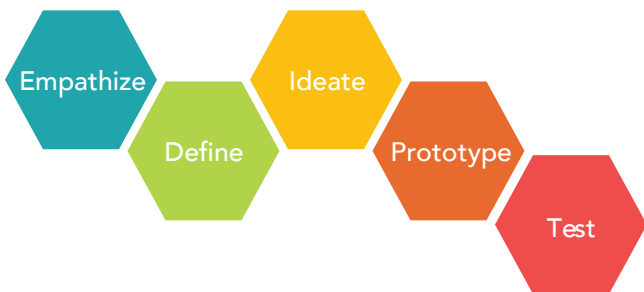

1. Design – helps students gain empathy through questioning, interviewing and primary source research. It helps students to see the value of adopting a human-centred approach to problem finding.
2. Tinker – supports making, testing, refining, failing, modifying, and trying again as part of an iterative process.
3. Thinker – encourages the observation of the work of others and the use of that understanding to tinker further, and modify and adjust one's initial ideas.
4. Reflect – provides time to consider what was done, what could be done, and to muse about the process/product/next steps. Reflection is the prompt for iteration and is essential to understanding that design thinking is a process (journey) not merely a product (destination).

The design challenge (pg.15) is the prompt or provocation for the *Taking Making into Classrooms: Ocean Toolkit* design process. Students consider the challenge by slowly engaging in a facilitated design process rather than rushing to tinker or explore materials and tools.

**Table 1-7: Taking Making into the Classroom's Cycle**

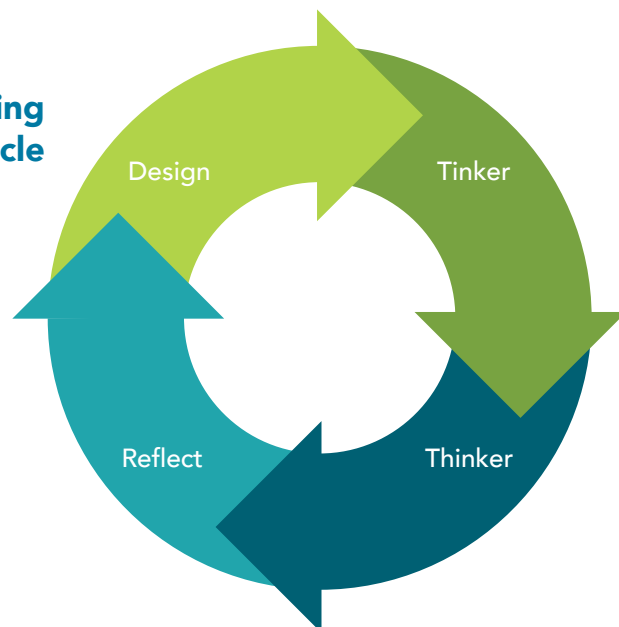

## How To Facilitate Design Thinking

As you consider how you might facilitate all of the phases included in a design thinking, intentional learning experience, please consider drawing on our suggestions listed below. The timing suggested in the following guide supports a full day maker experience, but recognize you can stop the process at any point to support research, exploration, prototyping, etc. As you become more comfortable facilitating this process, you will want to modify our suggestions, remembering we modified the process suggested by Stanford's d.School ([https://dschool.stanford.edu/groups/designresources/wiki/ed894/The\\_GiftGiving\\_Project.html](https://dschool.stanford.edu/groups/designresources/wiki/ed894/The_GiftGiving_Project.html)). We believe modification is the most sincere form of flattery, and we are grateful to d.School for leading the way. The ability to modify and share resources is one of the many reasons both Stanford and we offer our thinking through Creative Commons Licensing.

### Tinker<sup>1</sup>

Tinker is the second phase of the Taking Making into Classrooms cycle. It is through tinkering that students begin to make their thinking visible (Eisner, 1998). Tinkering or prototyping is done once the initial design has been sketched and negotiated. Typically, we encourage students to work in groups of four through the design thinking process, but that is an educator's decision—individual work or group work.

We recommend that students work within their groups to refine their sketches and add essential details and descriptions. As they do that, they begin to think aloud about the ideas and find different sources of the initial problem. Thinking aloud basically allows them to talk through the design process. When students engage in thinking aloud within a group, their classmates can engage with them as critical friends and offer timing supports, ideas, and modifications. Thinking aloud forms a link between tinkering and thinking in the design thinking cycle as it bridges initial ideas with more iterated, developed plans.

### Thinker<sup>2</sup>

Thinker is the third phase, and it helps groups to share their learning and to embrace the way that multiple points of view can result in divergent, ambidextrous thinking. Realizing that everyone started with the same design challenge and sample materials, tools, and resources, thinking during a gallery tour (or design charette) brings a forced stop to the tinkering and invites each group to summarize its activities—process and products. It requires all participants to become critical friends and to learn to ask good, fair minded, open questions. Students need time to learn to be critical friends, but there are support materials available (*i.e.* *Critical Friend Toolkit*, *n.d.*). The development of critical friends is part of developing a safe, risk-taking environment in which innovation and creativity are encouraged. We value the use of the revised Bloom's taxonomy questions as a way to introduce students to the types of questions that open conversations and encourage iteration (<https://www.cloud.edu/Assets/PDFs/assessment/revised-blooms-chart.pdf>). Tinkering and thinking are related to Papert's concept of hard fun.

Learning to ask good questions is an essential outcome of design thinking. People working in the fields of coaching and leadership (Whitworth, Kimsey-House & Sandahl, 1998; Payne & Hagge, 2009) suggest that powerful questions support open discussion and sustained dialogue. We have modified their suggestions on the following page.

---

<sup>1</sup> We define tinkering as the actual hands-on making of things based on a design. Tinkering produces a tangible but not necessarily final prototype, model or metaphor of a solution to a design challenge.

<sup>2</sup> We define thinking as the viewing of other design solutions. Viewing is similar to a Design Charette where peers observe and comment on the work of other peers.



## Opening Questions

- What is your intention?
- What impact might this have?
- What are some other possibilities?
- What other ideas do you have about it?

## Clarifying Questions

- What do you mean? Please tell me more.
- What concerns you most about this?
- What concerns do you still have?
- What more can you tell me?

## Probing Questions

- Can you give me an/another example?
- What have you tried so far?
- How did that work?
- What might be missing?

## Options

- What are other possible solutions?
- What would you like to see happen next?
- What else could you do?
- What other opportunities are there for this?

## Action Questions

- What are your next steps?
- What are you willing to do to refine this?
- What strengths do you see with this?
- What would be helpful in assisting you?

## Blocks

- What got in the way?
- What if this doesn't work, initially?
- What's your backup plan?
- Are you prepared to take this further?

## Reflect<sup>3</sup>

The reflect phase can be seen as the final phase of the design cycle or the start of iteration and re-design. It is a natural extension of the thinking process. We encourage both group reflection (part of the preparation for the gallery tour) as well as individual reflection, which is the fourth stage of the design cycle. Reflection helps students to make their thinking visible (Eisner, 1998) and consider what they have learned and when they need to learn. It can be used as part of formative assessment. It helps students to document their own learning, recognizing they can often be so busy in the process they forget what they actually learned. Reflection also helps with closure to a design challenge and can be used to inform the next steps in personalized learning. However, the most important thing reflection can do is to provide thinking time: time to consider what was done and why, what were the contributions, what could be better next time, etc. Reflection is essential for iteration because it helps inform what could be done next. In terms of the design process, reflection helps students see what they designed and then make decisions as to how that design could be better.

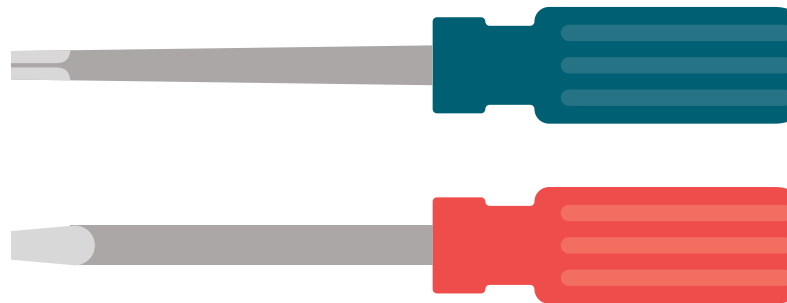

---

<sup>3</sup> We define reflect as the personal pause to consider one's work in light of other solutions and ideas. It is a necessary stop in the action before moving on to either a re-design or the next design challenge. It should play a significant role in the assessment process.

## Fostering Habits of Mind

We have found that by honouring all the phases of the design thinking cycle, students begin to gain competency in each of the six activities and learn to play hard. Through this purposeful play, students begin to develop habits of mind (Costa & Kallick, 2000) which include “16 problem solving, life related skills, necessary to effectively operate in society and promote

strategic reasoning, insightfulness, perseverance, creativity and craftsmanship. The understanding and application of these 16 habits of mind serve to provide the individual with skills to work through real life situations that equip that person to respond using awareness (cues), thought, and intentional strategy in order to gain a positive outcome.”

**TABLE 1-8: Habits of Mind**

<p><b>Persisting</b> Stick to it! Persevering at task through to completion, remaining focused. Looking for ways to reach your goal when stuck. Not giving up!</p>	<p><b>Thinking about your Thinking: Metacognition</b> Know your knowing! Being aware of your own thoughts, strategies, feelings, and actions and their effect on others.</p>
<p><b>Striving for Accuracy</b> Check it again! Always doing your best. Setting high standards. Checking and finding ways to improve constantly.</p>	<p><b>Thinking Flexibly</b> Look at it another way! Being able to change perspectives, generate alternatives, and consider options.</p>
<p><b>Questioning and Posing Problems</b> How do you know? Having a questioning attitude, knowing what data are needed and developing questioning strategies to produce those data. Finding problems to solve.</p>	<p><b>Responding with Wonderment and Awe</b> Have fun figuring it out! Finding the world awesome, mysterious, and being intrigued with phenomena and beauty. Being passionate.</p>
<p><b>Thinking and Communicating with Clarity and Precision</b> Be clear! Striving for accurate communication in both written and oral form; avoid over-generalizations, distortions, deletions, and exaggerations.</p>	<p><b>Creating, Imagining, and Innovating</b> Try a different way! Generating new and novel ideas, fluency, originality.</p>
<p><b>Managing Impulsivity</b> Take your time! Thinking before acting; remaining calm, thoughtful and deliberate.</p>	<p><b>Remaining Open to Continuous Learning</b> Learn from experiences! Having humility and pride when admitting we don't know; resisting complacency.</p>
<p><b>Listening with Understanding and Empathy</b> Understand others! Devoting mental energy to another person's thoughts and ideas; make an effort to perceive another's point of view and emotions.</p>	<p><b>Thinking Interdependently</b> Work together! Being able to work in and learn from others in reciprocal situations. Team Work.</p>
<p><b>Applying Past Knowledge to New Situations</b> Use what you learn! Accessing prior knowledge; transferring knowledge beyond the situation in which it was learned.</p>	<p><b>Taking Responsible Risks</b> Venture out! Being adventuresome; living on the edge of one's competence. Try new things constantly.</p>
<p><b>Gathering Data through all the Senses</b> Use your natural pathways! Pay attention to the world around you. Gather data through all the senses; taste, touch, smell, hearing, and sight.</p>	<p><b>Finding Humor</b> Laugh a little! Finding the whimsical, incongruous, and unexpected. Being able to laugh at one's self.</p>

Classroom Habitudes: Teaching 21st Century Learning Habits and Attitudes, <http://www.angelamaiers.com/2008/10/classroom-hab-2/>

## Habitudes to Start the Development of Creative Learning

Angela Maiers writes about developing “habitudes” in our classrooms. She suggests a habitude is the combination of habits and attitudes in a classroom context, and it requires teachers to move from a checklist of curricular things to cover to the creation of a learning environment that prompts deep and significant change in students. The following six habitudes identified by Maier are offered as a starting point for your own creative activities.

### Habitude 1: Imagination

A cardboard box; a basket of unfolded laundry; an individual blade of grass. To a child, these everyday, unnoticed items become a fort; clothing for a king and queen; a harmonica that plays symphonic music. Imagination is not just for kids. Discovery, innovation, creativity, and learning all begin with imagination. Everyone says imagination is important, but it’s something we take away by forcing students to memorize and repeat rather than think and envision.

### Habitude 2: Curiosity

Champion learners are curious about everything. They ask questions and get themselves involved in all stages of learning, without worrying about the answer, but relishing in the process. They have learned that by posing questions, they can generate interest and aliveness in the most exciting or mundane situation. This inquisitive attitude fuels their unrelenting quest for continuous learning.

### Habitude 3: Perseverance

I think of times in my life that it took more than “I think can” to get me to my goal. Most recently, I completed running in my first half marathon. Without resolve, determination, firmness, and endurance, I know I could not and would not have physically or mentally gone the distance.

### Habitude 4: Self Awareness

We all have strengths and weaknesses in regard to our learning performance and capabilities. Knowing yourself, knowing your strength, preferences, and areas of need is a critical characteristic of a successful learner. Yet, self-awareness is more than just recognition of what you can or cannot be, do, have. This innate ability to stay in tune serves multiple purposes. They can foresee problems and use their strengths to overcome difficulties encountered.

### Habitude 5: Courage

Courageous learners understand that safe is risky. Success is the byproduct of risk-taking, closing our eyes, saying I will not let fear hold me back, and taking the plunge. I want them to understand that it takes courage to address the voices in your head that echo doubts, questions, or other paralyzing thoughts.

### Habitude 6: Adaptability

Adaptability is more than just serving change; it is using change as a growth opportunity. In fact, with anticipation of change, you can control change. This kind of development requires robust adaptively. The world opens up for adaptable learners, as they approach each task, each challenge willing to be a beginner. They approach their learning and life with a beginner’s mindset. These learners embrace challenge with openness, flexibility. Those who don’t embrace change with adaptability usually get blind-sided by it (Classroom Habitudes: Teaching 21st Century Learning Habits and Attitudes, <http://www.angelamaiers.com/2008/10/classroom-hab-2/>).

We know you will develop more examples of these habitudes that are situationally and culturally relevant in your classrooms and schools. We see a natural link between habits of mind, habitudes, and design challenges, and we believe that together the parts make for an intentional approach to Taking Making into Classrooms.

## Traits of A Design Thinker

It is not surprising that Tim Brown, CEO of innovation and design firm IDEO ([www.ideo.org](http://www.ideo.org)), identified developing the following traits as essential for design thinkers.

- Empathy – Ability to image the world from multiple perspectives
- Integrative thinking – Exploit opposing ideas and opposing constraints to create new solutions
- Optimism – Assume no matter how challenging the constraints of a given problem, at least one potential solution is better than the existing alternatives
- Experimentalism – Pose questions & explore constraints in creative ways that proceed in entirely new directions
- Collaboration – Complex problems require an enthusiastic interdisciplinary collaborator (Brown, 2008, p. 87, [https://churchill.imgix.net/files/pdfs/IDEO\\_HBR\\_DT\\_08.pdf](https://churchill.imgix.net/files/pdfs/IDEO_HBR_DT_08.pdf))

Design thinking is a human centred design process that seeks to gain empathy for a situation by developing understanding of the concerns, insights, lived experiences, and/or needs of others. The initial step in design thinking is gaining empathy through interviews.

At the heart of good interviews are great questions — questions that are open, engaging and politely probing. It is through open questions that the person who is being interviewed can share what they are comfortable sharing and often be engaged in a conversation that is rich and illuminating to both the interviewer and the interviewee.

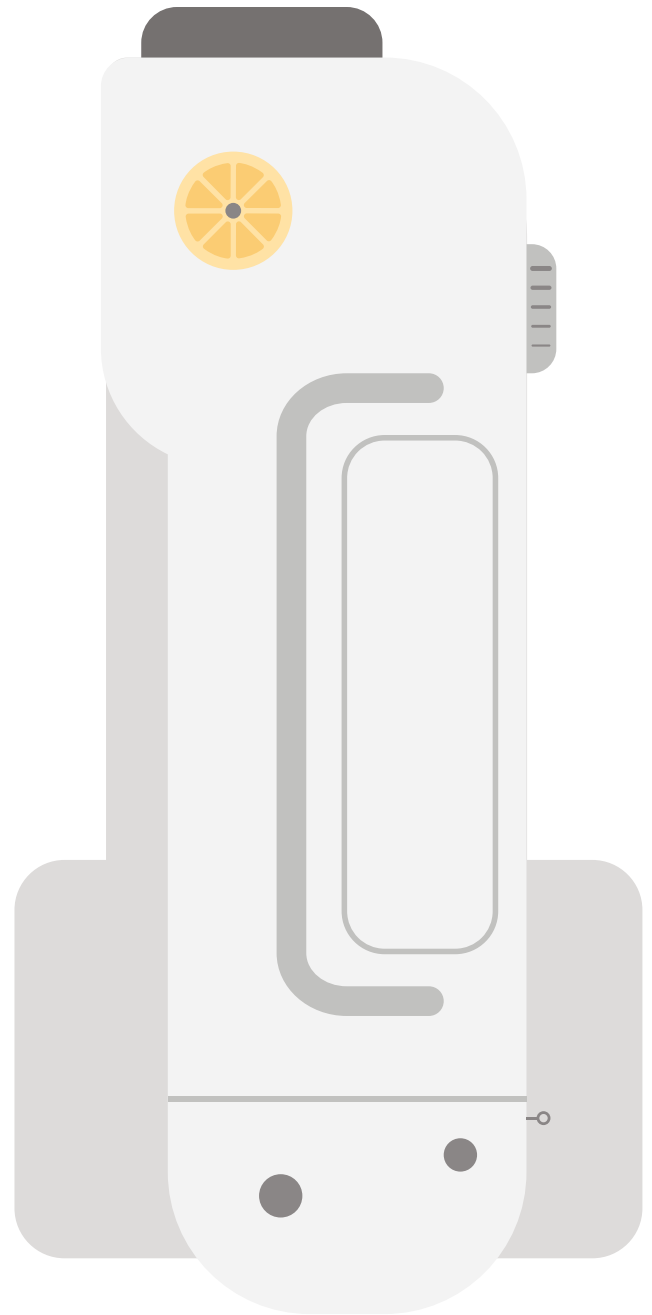



## SAFETY ISSUES

### Introduction

Taking Making into Classrooms is different from opening a school shop and periodically using the equipment without paying any mind to the potential hazards. Rather, teachers who incorporate making and design thinking into their classrooms must be aware of everything from safety equipment (i.e. eye and ear protection) to tool training changes and the most appropriate materials that are available for student use.

### Linking Safety, Intent to Tools and Spaces

We take a just-in-time approach to safety issues, in order to introduce the need to be safe and maintain safe work spaces in a timely and situational manner. We know that students and teachers need to work safely, and safety issues are not something that should be taught to students in order to instill a fear of working with tools. Instead, safety should be taught to students to promote a sense of empowerment and confidence in their skills.

When we can use powerful tools safely, we are empowered to do more and to try more. Empowerment is a strength-based approach to learning. Empowering both teachers and students allows them to overcome the mindset that tells them they won't succeed due to factors like age, gender, or a lack of experience.

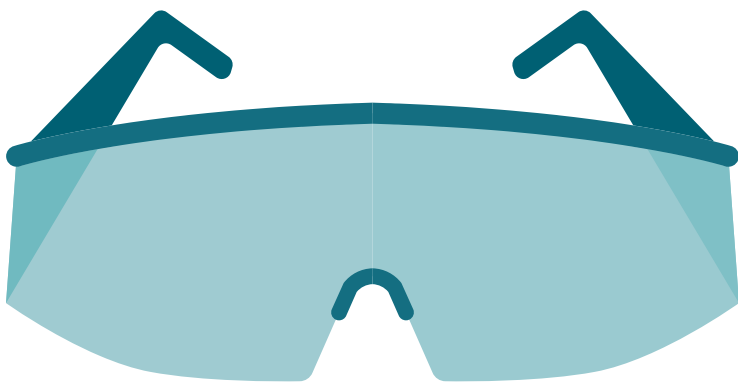

**TABLE 1-9: Mapping Learning Intentions, Tools and Safety**

	Learning Intention	Basic Tools	Initial Safety Concerns
Introductory, Inexpensive, Simple	<b>Design and Basic Making</b>	Hand tools, including glue guns, rulers, knives, scissors, etc.	<p>Emphasis is on accurate measuring, safe cutting, and careful assembly.</p> <ul style="list-style-type: none"> <li>• Use of ruler both for measuring and as a straight edge to cut against</li> <li>• Safe ways to walk holding sharp objects</li> <li>• Safe ways to use hot elements like glue guns and hot glue</li> <li>• Ways to help your group members—where to stand, how to hold things, use of tools with and among other people</li> </ul>
	<b>Design and Simple Prototyping</b>	Hand tools and simple power tools such as Dremel tools, electric drills, etc.	<p>Focus is on accurate measuring, safe cutting, and careful assembly; emphasis is on the selection of the appropriate tool for the task.</p> <ul style="list-style-type: none"> <li>• See above</li> <li>• Use of v-blocks and clamps to hold materials prior to drilling, cutting or shaping</li> <li>• Use of eye and ear protection for user and those immediately around them</li> <li>• Use of gloves where appropriate</li> <li>• Use of drill bits and Dremel attachments</li> <li>• Use of extension cords, cables, power bars, etc.</li> </ul>
Advanced, Expensive, Complex	<b>Design and Fabrication</b>	Hand and power tools with option for 3D printers, CNC machines, etc.	<p>Focus is on accurate measuring, safe cutting, and careful assembly; emphasis is on the selection of the appropriate tool for the task.</p> <ul style="list-style-type: none"> <li>• See above</li> <li>• See safety concerns specified by specific tool to be used</li> <li>• Address issues of ventilation and air quality</li> </ul>
	<b>Design, Prototyping, Circuitry and Coding</b>	Hand and power tools, soldering irons, circuits, breadboards, etc.	<p>Focus is on accurate measuring, safe cutting, and careful assembly, and the selection of the appropriate tool for the task; emphasis is on the addition of functionality to the design through the inclusion of circuits and coding.</p> <ul style="list-style-type: none"> <li>• See above</li> <li>• Address issues of ventilation and air quality, especially when soldering</li> </ul>



## HOW YOU MIGHT...

### ...Create a Safety Station

Consider ways in which you might create a safety station where students can be shown the proper way to use the available tools and materials available.

Is there expertise you can draw on—colleagues who have Red Seal certification, knowledgeable colleagues who are makers, parents, or community members who can help you to hone your skills? Do you know someone who could help with the set up and introduction of your Safety Station, etc.?

### ...Explore Safety Resources

Explore the safety resources that are available and ensure you have the necessary safety equipment and expertise.

LIST OF N.S. RESOURCES / SKILLS CANADA





## SUGGESTED RESOURCES: AN ANNOTATED BIBLIOGRAPHY OF ESSENTIAL READINGS AND REFERENCES THAT INFORMED THIS TOOLKIT

### Things to Explore

#### Maker Ed

<http://makered.org/about-us/who-we-are/>

#### Edutopia

[http://www.edutopia.org/blog/maker-tools-and-theiruses-vicki-davis?utm\\_source=SilverpopMailing&utm\\_medium=email&utm\\_campaign=072314%20enews%20maker%20ngm%20B&utm\\_content=&utm\\_term=feature3hed&spMailingID=9072925&spUserID=MjcyODg5Njl0MjMS1&spJobID=341826896&spReportId=MzQxODI2ODk250](http://www.edutopia.org/blog/maker-tools-and-theiruses-vicki-davis?utm_source=SilverpopMailing&utm_medium=email&utm_campaign=072314%20enews%20maker%20ngm%20B&utm_content=&utm_term=feature3hed&spMailingID=9072925&spUserID=MjcyODg5Njl0MjMS1&spJobID=341826896&spReportId=MzQxODI2ODk250)

#### Instructables

<http://www.instructables.com/>

#### Make:

<http://makezine.com>

#### Quirky

<https://www.quirky.com/how-it-works>

#### The Tinkering Studio

<http://tinkering.exploratorium.edu/>

#### Stanford's d.School

<http://dschool.stanford.edu/>

#### Maker Day Toolkit, Version 2

<https://issuu.com/ubcedo/docs/makerdaytoolkitver2revisemay31e>

### Educational Makerspaces and Resources

<http://www.makerspaceforeducation.com/>

This is an amazing resource developed by Trisha Roffey, an Edmonton educator with a passion for making and making a difference in education. This site was developed as part of her Master of Education Technology at UBC.

#### Mindset Kit

[https://www.mindsetkit.org/?utm\\_source=Mindset+Kit+Updates&utm\\_campaign=8efa5e8708-7\\_11\\_16\\_MSK\\_List\\_First\\_Step\\_Language&utm\\_medium=email&utm\\_term=0\\_fb3a4dfa59-8efa5e8708-85733961](https://www.mindsetkit.org/?utm_source=Mindset+Kit+Updates&utm_campaign=8efa5e8708-7_11_16_MSK_List_First_Step_Language&utm_medium=email&utm_term=0_fb3a4dfa59-8efa5e8708-85733961)

Comprehensive collection of lessons, ideas, prompts and research supporting the importance of fostering a growth mindset.

### Inclusive Makerspaces—Consideration of UDL and Accessibility

#### Making a Makerspace? Guidelines for Accessibility and Universal Design

<http://www.washington.edu/doit/making-makerspaceguidelines-accessibility-and-universal-design>

#### Making for All: How to Build an Inclusive Makerspace

<https://www.edsurge.com/news/2015-05-10-making-for-all-how-to-build-an-inclusive-makerspace>





## Innovations in Education

<https://flipboard.com/@daveheteri51jh/innovativeeducation-8g0te485y>

## Libraries as Makerspaces

<http://www.theatlantic.com/technology/archive/2016/03/everyone-is-a-maker/473286/>

## Makerspaces are everywhere

<http://www.spencerauthor.com/2016/04/you-dontneed-makerspace-to-have-space.html/>

## Resources to Support Design/Ideation

### The Smithsonian Learning Lab

<https://learninglab.si.edu/>

The Smithsonian Learning Lab provides access to ideas, materials, resources, learning resources drawn from their vast collection.

### Innovations in Education

<https://flipboard.com/@daveheteri51jh/innovativeeducation-8g0te485y>

## Things to Read

### Design Kit

<http://www.designkit.org/>

Design Kit breaks down the methodology and the mindset of human-centered design.

### IDEO Design Thinking for Educators

<http://www.designthinkingforeducators.com/>

From the website: This toolkit contains the process and methods of design along with the Designer's Workbook, adapted specifically for the context of K–12 education.

### Rubber Band Engineer

<https://www.amazon.com/Rubber-Band-Engineer-Slingshot-Unconventional/dp/1631591045>

A book by Lance Akiyama. Brilliant resource with clear directions and examples for building hand-held shooters, mini seige engines, hydraulic and pneumatic power devices, rockets and helicopters, and propellerpowered cars. An example of his designs can be found at <http://makezine.com/projects/construct-funpowerful-rubber-band-crossbow/>. The challenge for school settings is the first 36 pages includes guns, rifles, and other hand-held devices that could be problematic in school settings. The introduction to hydraulic and pneumatic power is excellent!

### ADST framework

<http://innovativelearningcentre.ca/wp-content/uploads/2014/09/applied-skills.pdf>



## Safety Resources

### Heads Up for Safety

<http://www.bctea.org/heads-up-for-safety>

### Student Work Safe–WorkSafe BC

<https://www.worksafebc.com/en/health-safety/education-training-certification/young-newworker/student-worksafe>

### Heads Up—Work Smart

<http://headsupab.com>

### For Educators

<http://www.bcpsea.bc.ca/bc-teachers/workplacesafety.aspx>



# DESIGN CHALLENGE 1: WHERE DID MY BEACH GO?

## OVERVIEW

The process of erosion occurs around us all of the time. It is a natural phenomenon that impacts humans in both positive and negative ways. Coastal erosion is generally perceived as negative as it impacts coast lines, coastal services and coastal habitation.

## DESIGN RATIONALE

This design addresses issues in the topics below:

- Issues of coastal erosion
- Outline aspects of erosion that have positive impacts (i.e. river formation) and negative impacts (property & habitat destruction)
- Social/ecological impacts
- Frame story by establishing what erosion is through pictures.



## PROBLEM SCENARIO

Lawrencetown beach\* is located within a well populated area of eastern Nova Scotia. (\*the location can be changed to represent a local area that experiences erosion). Lawrencetown beach is known for its large waves and as a result is a renowned surfing area. The area also supports a broad and active community, with housing, biking trails and opportunities to be close to nature. Over the past few years, as a result of increased wave action due to stronger and more prevalent storms and rising sea level, the beach and surrounding area is being eroded at accelerated rates. Your team has been hired, based on your expertise in mediating coastal erosion, to design a solution to the Lawrencetown beach crisis. Your team has the task of designing a structure that will reduce the impacts of

erosion. It is important that you pay attention to the details of the ecosystem and the various stakeholders involved. Be careful your solution doesn't cause additional problems!

Each team will be assigned a specific role within the community that will shape their design and solution to the erosion crisis. Stakeholder groups can include:

- Homeowners
- Surfers
- Insurance companies
- Environmentalists
- Government
- Tax payers (who do not live in the area)
- Indigenous peoples

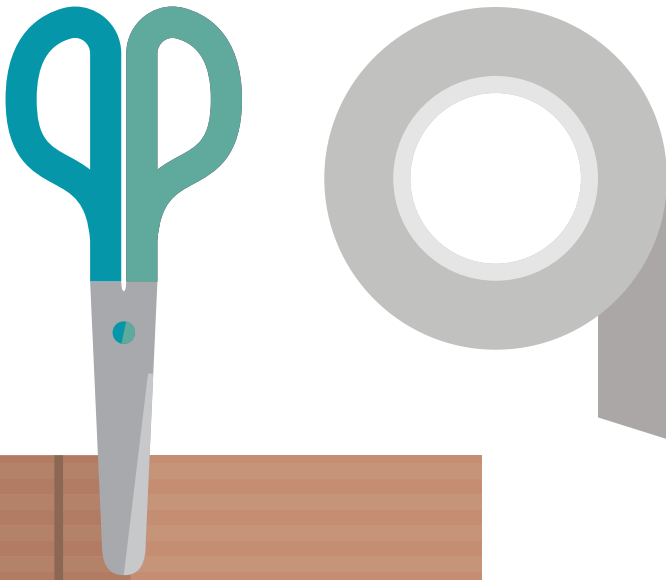

## SUCCESS DETERMINANTS

- You will create a plan, providing a sketch and rationale for their design.
- You will research the future impacts of implementing their structures into the area.
- You will reflect on what you've done that worked, what didn't and where improvements can be made.

## PARAMETERS

- You must stay within the given budget to purchase materials
- You can use items and materials from the pantry and also bring in recycled materials from home (*i.e. beautiful junk<sup>1</sup>*)
- You can use any of the tools that have been provided, or use tools from home (*with permission and supervision*)
- Your prototype could be a scale version rather than actual size (*size constraint for model should be communicated*)

## SUGGESTIONS FOR USE

Originally conceived with grades 11 and 12 in mind.

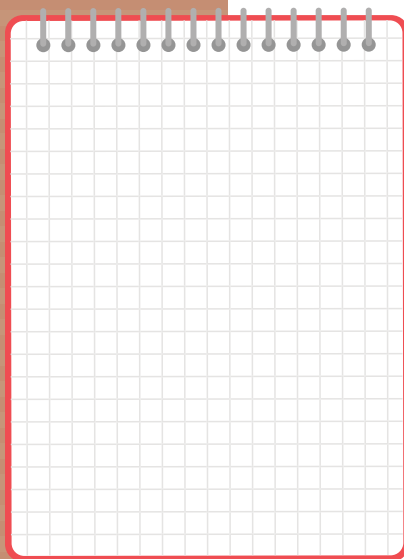

---

1. Beautiful junk is any recycled material that can be reused and re-purposed for your new designs. Students are encouraged to reuse old materials rather than buying new materials.

# DESIGN CHALLENGE 2: INHABITING ATLANTIS / FINDING A HOME

## OVERVIEW

The IPCC special report on the impacts of global warming (<http://www.ipcc.ch/>) has reported that rising global temperatures could create the types of environmental challenges that could make some places unlivable within the next 20 years. We might need to consider other environments, and

while life on Mars may be an option in 50-100 years, in the next 20 years we might need to consider moving into an ocean habitat where we are less exposed to air and soil pollutions. What would have to be considered to make it possible for humans to relocate from terrestrial habitats to a water environment?

## DESIGN RATIONALE

Students will reflect on the most basic human needs and prioritize the elements of their living environment as they design a livable underwater habitat for humans. Students may want to consider Maslow's Hierarchy of needs as they consider and prioritize features of their design. Students will also need to consider their own

knowledge and experiences about ecosystems and cycling of matter, as well as concepts relating to sustainable ecosystems; conditions for life, cycle of matter, resource use and development, weather and weather changes. Learning will need to consider what is needed most in order to live and thrive in their "new ocean home".



## PROBLEM SCENARIO

The impacts of climate changes have decimated terrestrial environments, leaving continents uninhabitable. The only resort is for humankind to return to their primordial birth place, our Ocean. Using your knowledge about ocean ecosystems, coupled with what human beings need to survive, it is your job to design and construct a prototype of a livable habitat that can hypothetically be placed underwater and withstand all the elements of the ocean (depth, pressure, temperature, etc).

Please address these types of challenges (and others that you come up with) within your design.

*What do we need first:*

- Shelter? Water? Air? Food?
- Considerations about chemical processes, cycling of matter in closed ecosystems;
- Life Science: Ecosystem
- Physical Sciences: Chemical reactions



## SUCCESS DETERMINANTS / PARAMETERS

- Addresses the design challenge
- Addresses an identifiable need for the end-user
- Demonstrates awareness of critical needs for human life
- Demonstrates awareness of the unique considerations of a marine environment

## LITERARY RESOURCES

1. IPCC special report on the impacts of global warming. <http://www.ipcc.ch/>
2. Book Series: The City of Ember
3. Book Series: Gregor The Overlander
4. Author Patrick Roy – Submarine Outlaw
5. The Hatchet By: Gary Pulson

## SUGGESTIONS FOR USE

Originally conceived with grades 9-10 in mind.

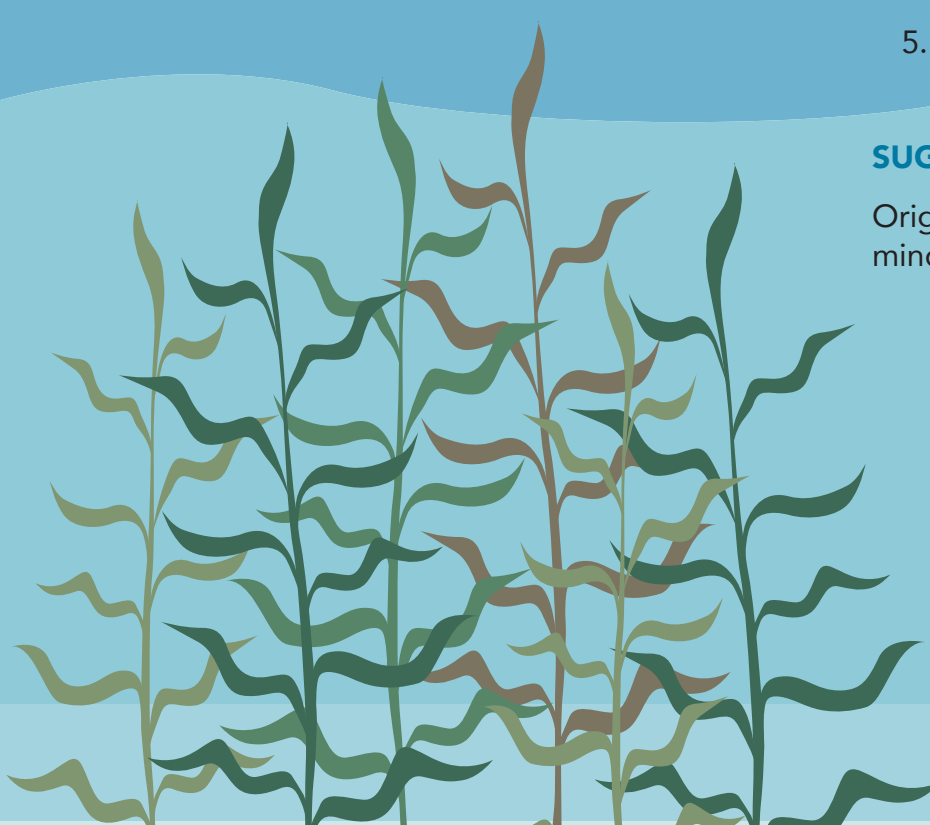

# DESIGN CHALLENGE 3: WATER, WATER EVERYWHERE, BUT NOT A DROP TO DRINK!

## OVERVIEW

71% of our Earth is water-covered and the oceans hold about 96.5% of all Earth's water. There are freshwater shortages globally and this is an important issue for food security. The desalination industry has continued to grow and find new ways to separate salts from seawater. Your design challenge is to create and design a tool to remove salt from seawater.



## DESIGN RATIONALE

We want our students to expand on their understanding of how plants grow. They will develop their empathy and awareness of the continental water shortage. We want to increase their understanding of oceans as a resource to sustain our environment. They will also develop their understanding of the interconnectedness of ocean plants and animals and their life-cycle.

## PROBLEM SCENARIO

Our students are stranded on McNab's Island with oceans of water around them. They have a small supply of food and seeds to grow new plants. They need to figure out a way to grow more food with the endless amounts of salt water they have at their disposal.

## SUCCESS DETERMINANTS

- Learners will be able to collaborate to create and innovate
- Use design thinking to generate innovations
- Gather information through all senses to imagine, create, innovate
- Take responsible risk, accept critical feedback, reflect and learn from trial and error
- Engage in constructive and critical dialogue
- Designs will demonstrate an awareness of the water cycle
- Use equipment properly to collect data about air and water
- Make observations and record data about the life cycle and growth of animals
- Describe features of natural and human-made environments that support the growth of some familiar animals
- Record information from investigations of solutions made from simple substances, such as salt and water
- Design a fair test on the motion of constructed objects
- Describe how various conditions impact plant growth through a fair test.

## PARAMETERS

- You will have a common kit of materials to be shared in groups
- You can use items from the pantry
- You can use any of the tools that have been provided.
- Your prototype could be a scale version rather than actual size
- You can bring items in from home for your group or for the shared pantry
- The size of the apparatus must fit on the top of a student desk and be no higher than 3 feet above the desk.
- You may work in groups of 2-4

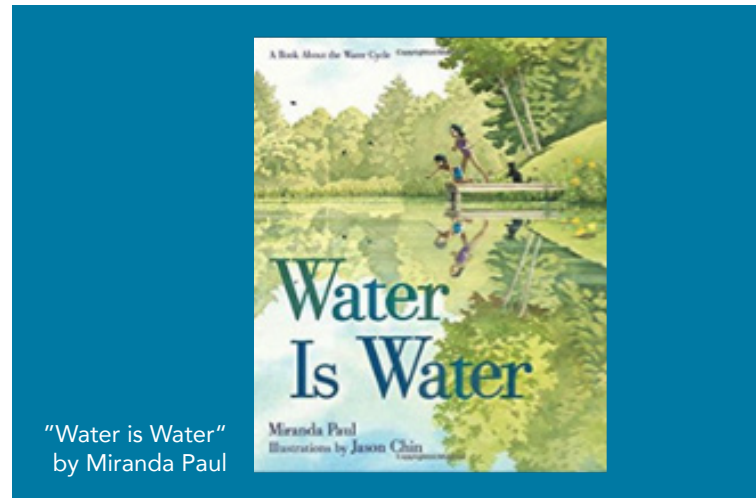

## LITERARY RESOURCES

1. Ocean Literacy: <http://oceanliteracy.org/wp2.coexploration.org/>
2. Ted Talks: <https://ed.ted.com/lessons/the-motion-of-the-ocean-the-concentration-gradient-sasha-wright>
3. [https://www.ted.com/talks/damian\\_palin\\_mining\\_minerals\\_from\\_seawater](https://www.ted.com/talks/damian_palin_mining_minerals_from_seawater)
4. <https://www.youtube.com/watch?v=TWb4KIM2vts> (Water Cycle Song)
5. Food Secure Canada: <https://foodsecurecanada.org/>
6. Water Cycle Go Noodle: <https://www.youtube.com/watch?v=KM-59ljA4Bs>
7. Cape Town, continent of Africa - running out of water and how they are remedying the situation

## SUGGESTIONS FOR USE

Originally conceived with grades 4-5 in mind.

## DESIGN CHALLENGE 4: PROTECTING SEA TURTLE EGGS

### OVERVIEW

Leatherback sea turtles migrate to the Atlantic waters after they have laid their eggs. They are an endangered species due to pollution, entanglement, human interaction and natural predators to name a few.

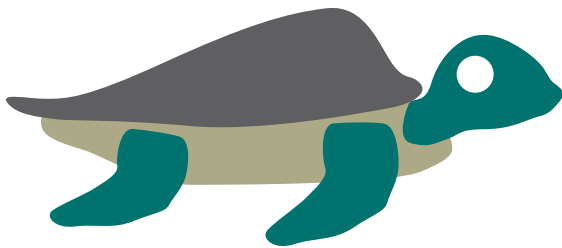

*"They are the largest sea turtle species and also one of the most migratory, crossing both the Atlantic and Pacific Oceans. Pacific leatherbacks migrate from nesting beaches in the Coral Triangle all the way to the California coast to feed on the abundant jellyfish every summer and fall."*

- World Wildlife Federation

### DESIGN RATIONALE

Students will have an opportunity to consider the sea life that lives within their own ocean waters. Their research will look into why leatherback sea turtles are coming to our waters. What do Atlantic waters provide for the leatherback sea turtles that other waters they travel through do not? For this task, students will consider why it is important to understand why the

leatherback sea turtle eggs are at risk. They will also consider how their design enhances the environment it is to be used in, rather than further damaging it (i.e. build a contraption that is biodegradable as it will be close to the ocean, and that won't trap/injure other coastal critters). This contraption must especially be a safe habitat for the eggs and for the tiny turtles who eventually emerge from it.

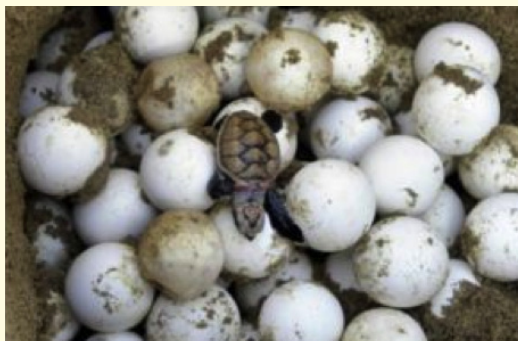

### PROBLEM SCENARIO

You are at the beach and see a leatherback sea turtle laying her eggs. You look around and wonder how these eggs are going to survive. With your team, consider what potential dangers exist on the beach, and build the ultimate contraption to protect Leatherback sea turtles' eggs.

## SUCCESS DETERMINANTS

- Designs will demonstrate that students have explored a variety of local natural habitats and have considered the interrelatedness among animals, plants and the environment in local habitats
- Design illustration communicates functionality
- Uses the provided materials, resources, and tools
- Materials need to be biodegradable
- The materials used cannot cause physical harm to any other living things (*on land and in water*)
- Shows evidence of your groups understanding of leatherback sea turtle eggs and what they require to survive
- Show awareness of the various hazards and dangers (*i.e. human, animal, weather*) that need to be considered
- Your contraption is well constructed from an engineering perspective as well as from an environmental perspective

## PARAMETERS

- You can use items from the pantry
- You can use any of the tools that have been provided.
- You can bring items in from home for your group or for the shared pantry
- Your prototype could be a scale version rather than actual size (*the size of your contraption cannot impede anything in the surrounding environment*)
- You must use your research and any prior knowledge of turtle nests when designing your contraption

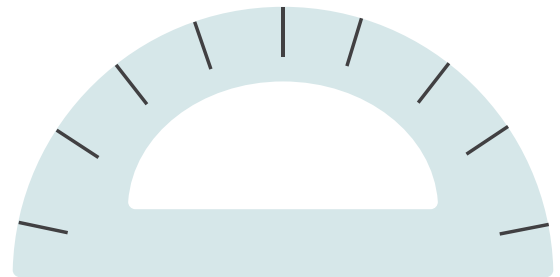

## RESOURCES

1. Canadian Registry of Species - [https://www.registrep-sararegistry.gc.ca/species/speciesDetails\\_e.cfm?sid=1191](https://www.registrep-sararegistry.gc.ca/species/speciesDetails_e.cfm?sid=1191)
2. World Wildlife Federation: Leatherback Sea Turtles - <https://www.worldwildlife.org/species/leatherback-turtle>
3. Canadian Sea Turtle Network: <https://seaturtle.ca>

## SUGGESTIONS FOR USE

Originally conceived with grades 3-4 in mind.

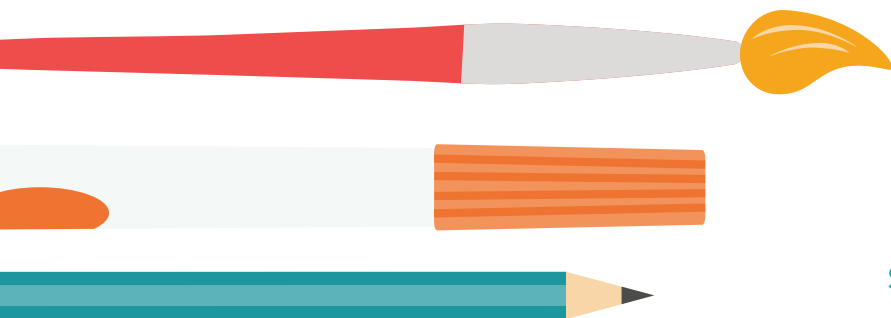



# DESIGN CHALLENGE 5: SHIPWRECKED!

## OVERVIEW

Many of us are so accustomed to our day-to-day lives that we don't realize how easily our survival needs are met. What do we really need to survive? What are our basic needs? How have we adapted to our environments by creating products that make it easier, safer or more comfortable to survive? If those comforts suddenly disappeared, what would we need to do on our own to ensure our survival, and how would we prioritize those needs? For this activity, you and your team have been lost in a storm and are shipwrecked on an island off the coast of

Nova Scotia. You need to figure out how to survive on the island until you are rescued or can find a way off. What would you find on the beach that you could re-purpose?

## RECOMMENDED EXPERIENCE

Field trip to McNab's Island (*Friends of McNab's Island*) or another coastal island - explore coastal habitats (*beach and intertidal pool, animals on and in the water around the island*). Find and research an island off the coast of NS (*or your province*).

### DESIGN RATIONALE #1

In order to live on the island, you need to protect yourself from the elements You are trying to survive on the island. Weather can be harsh including wind, heat, rain and cold.

### PROBLEM SCENARIO #1

How will you build your shelter to protect you from the environment on your island?

### SUCCESS DETERMINANTS

- Explanation of how your shelter will protect you from the elements and how it will withstand those elements

### PARAMETERS

- Your model must be made of materials you can find on your island including items that might wash up on the beach (*Friends of Sable Island*)

### DESIGN RATIONALE #2

While you were building your shelter you realized you became very thirsty. You need to find clean water. How will you keep hydrated. You can't live long without water.

### PROBLEM SCENARIO #2

You are on an island in the ocean that does not have freshwater (*i.e. no lakes or rivers*). You will need to build a tool for collecting and storing drinkable water.

### SUCCESS DETERMINANTS

- Explain your water collection system to make sure you have enough clean water to drink.

### PARAMETERS

- Your model must be made of materials you can find on your island including items that might wash up on the beach

### DESIGN RATIONALE #3

You know that winter is coming soon. You need to leave the island to make it home to the mainland. No boats or planes have noticed your signals.

### PROBLEM SCENARIO #3

You will need to consider how to design a vessel that will get you to the mainland a few kilometers away. You have weather, tides, currents, and cold temperatures to contend with. How will you get home safely?

### SUCCESS DETERMINANTS

- Prototype of flotation device needs to float in water. It has to withstand tides and currents and wind. (*fan, paddle??*) Your device CANNOT sink.

### PARAMETERS

- Your model must be made of materials you can find on your island including items that might wash up on the beach

### RESOURCES

1. Friends of McNab's Island - field trip/tour
2. Friends of Sable Island - Zoey Lucas / shipwrecks, weather stations
3. Videos from Ocean School? (100 wild islands, Friends of Sable Island)
4. Atlas, Google Maps

### SUGGESTIONS FOR USE

Originally conceived with grades 3-4 in mind. *Curriculum links to;* habitats, food chains, social studies (exploration, relationships between humans and the physical environment).

### ADDITIONAL SUBJECT INTEGRATION

Writing stories of their survival on the island or their experience in the storm on the way. Sharing their ideas, Presenting their ideas and design concepts. Listening to stories of early Mi'kmaq survival stories and building shelters, canoes etc.



# DESIGN CHALLENGE 6: DESIGNING OCEAN-FRIENDLY PRODUCTS

## OVERVIEW

Many of the products that we use end up as garbage dumped into the ocean. These products are harmful to the ocean creatures and to the environment generally, and many of these products will take thousands or millions of years to breakdown – meaning they are a very long-term problem.



## PROBLEM SCENARIO

Students will research common types of marine garbage (*i.e. fishing nets, water bottles, flip flops, etc.*) and will choose one to focus on.

## RATIONALE

Students use their understanding of the environment (recyclable, reusable, biodegradable materials) and how to build structures (materials & structures science unit) to design and build an environmental and ocean friendly product.

In their groups they will redesign that product with easier recycling, reusing, reduced materials, or biodegradable materials in mind.

## PRE-TEACHING

- What animals are found in the ocean around Nova Scotia (*jellyfish, crabs, turtles, dolphins, turtles, etc.*)
- Products that harm ocean creatures & how (*plastic bag, 6 pack ring, pop can, tin foil, etc.*)

*\*Plastic bag - looks like jellyfish so they try to eat it- eat it or get stuck in it*

*\*Tin foil - shimmers so attracts fish but they can't digest it*

- Recyclable, biodegradable, more than 1 use (*Resource: All the Way to the Ocean by Joel-Harper book (read aloud YouTube video)*)

## SUCCESS DETERMINANTS

- Your design must still fulfill the function of the original product
- Your design is more environmentally and ocean-friendly
- You haven't just created a new form of garbage, and production of your design isn't more resource intensive than the original (*footprint of production*)
- Your design is esthetically appealing to consumers – will they want to buy it
- Your design can be sold to consumers for roughly the same price
- Your design must also show consideration for sea creatures that might try to eat it (*i.e. avoid shapes or colours that might mimic food in the ocean*)

## PARAMETERS

- You can use items from the pantry
- You can use any of the tools that have been provided.
- You can bring items in from home for your group or for the shared pantry
- Your prototype could be a scale version rather than actual size
- You need to design and build something that floats
- Your design must fit in the float tank at school (*predetermine the size/ footprint*)
- Your group must work within an assigned budget (*Students are given a budget and each item available to use given a dollar value*)
- Your group will create a compelling advertisement to promote your product and explain why it is a more ocean-friendly option

## RESOURCES

1. Video: Life of a Plastic Bag -shows how the bag ends up in the ocean
2. Picture of an ocean animal (turtle) with a garbage bag stuck in his mouth
3. Clip at end of video - Simpsons Beach episode - crab in a pop can
4. All the Way to the Ocean by Joel-Harper book (*read aloud youtube video*)
5. Oceancrusader.org (*website shows how long item last in the ocean*)
6. Video: ocean garbage bag
7. Zoe Lucas tracks garbage floating to Sable Island (*Friends of Sable Island*)
8. Happy Feet Movie (*penguin has ring from 6 pack holder around his neck*)

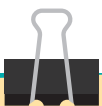

## SUGGESTED MATERIALS

- Brown paper
- Burlap (dollar store)
- Cardboard Boxes
- Wood
- Twine (hemp cord)
- Vegetable leather (*purée vegetables, pour on parchment paper, put in oven lowest temp for 12 hours*)
- Painters tape
- Egg cartons

## SUGGESTIONS FOR USE

Originally conceived with grades 3-4 in mind. *Curriculum links to; material structures, math (estimation, adding dollar values, budgeting, and persuasive communication.*

## DESIGN CHALLENGE 7: TURTLE PATROL

*Note: The teacher will explain the project to the students. Students in lower elementary are not expected to read the directions/outline below.*

### OVERVIEW

In Nova Scotia, we are surrounded by the Atlantic Ocean which is the home for many exciting animals such as the Atlantic Leatherback sea turtle. Leatherback sea turtles are huge in size and they often get tangled in fishing gear or eat our plastic pollution. The Atlantic Leatherback sea turtle is now endangered. This means they could soon become extinct! Unfortunately, all sea turtles, not just the leatherback, are endangered!

Endangered leatherback and loggerhead sea turtles spend time in the Atlantic waters feeding on jellyfish. Turtles face many threats to their survival in the open water of the Atlantic. Predators and humans are the first threat to the survival of sea turtles when eggs are laid on sand nests on the beaches of the tropics.



### DESIGN RATIONALE

Sea turtles enjoy our Canadian waters but swim to warmer waters around the United States, Mexico, and tropical places such as Trinidad and Tobago to lay their eggs on the warm, sandy beaches. But, the eggs are often dug up or destroyed by predators before they can even hatch!

People try to protect the sea turtle nests by putting up signs and special tape to keep people away from the nests so the eggs can hatch. However, sometimes people don't read the signs, or the special tape blows away creating more pollution on the land and in the water. Predators are always looking for food and think sea turtle eggs are very yummy. Sea turtles are in great danger of becoming extinct and disappearing from our oceans forever.





## PROBLEM SCENARIO

While on vacation with your family in Trinidad, you are enjoying a warm walk along the sandy beach. You suddenly come across a nest of sea turtle eggs! Knowing how special these animals are, you want to help protect the eggs so they can hatch and return to the ocean to grow into beautiful adult sea turtles to swim back to our Canadian oceans.

Your job is to join a team of students to create a structure to protect the sea turtle eggs from humans and predators until they hatch. When building your structure, you need to think about the environment around the nest and the needs of the sea turtle eggs. You don't want your structure to blow apart into the environment, and you want the eggs to have everything they need to grow into healthy baby sea turtles.



## TURTLE PATROL cont.

### SUCCESS DETERMINANTS

- Your materials must be secure enough to not be blown away from natural elements (therefore creating pollution) *tested with a hairdryer*
- Your sun must be able to penetrate the structure in order to support egg development test with a flashlight
- Your design must include an exit to ensure there is a way for the turtle to leave the protected area once hatched.

### PARAMETERS

- You can use items from the pantry
- You can use any of the tools that have been provided.
- You can bring items in from home for your group or for the shared pantry
- Your design must fit within a (standard or non-standard units) specified height and length
- Your team will explain who/what your structure will protect the eggs from and how
- As each team presents, consider how the best parts of each different design could be combined to create an improved collaborative design





## SUGGESTIONS FOR USE

Originally conceived with grades 3-4 in mind.

*Curriculum links to;*

- exploring living things
- social strategies of collaboration and cooperation in problem solving
- communication (seeking and sharing information, turn-taking)
- measurement
- the needs of living things
- materials and their properties
- construction

# DESIGN CHALLENGE 8: OCEAN FRIENDS

## OVERVIEW

Marine garbage is a huge and growing problem. The Great Pacific Garbage Patch, a collection of plastic, floating trash halfway between Hawaii and California, has grown to more than 600,000 square miles – that’s three times the size of France! In addition to being an eyesore, this garbage is polluting

the water environment it is in, as it slowly breaks-down releasing chemicals and micro-plastics into the surrounding environment. It also presents an immediate danger to marine wildlife who swim, float or feed within this area.

## DESIGN RATIONALE

It is important to understand that the ocean is an integral component of our everyday life. Overfishing, invasive species, pollution, mass die-offs, and warming ocean temperatures are only a few of the issues our oceans face. It is time for humans to take responsibility for the past and present behaviours that have caused these marine

challenges – and continue to cause them. On one side of the problem we can tackle the sources of these problems and work to change our ways of life to minimize our impact on the terrestrial and marine environments we live in. But we must also address the mess we have made – because it won’t go away on its own.



## PROBLEM SCENARIO

Your eco-team has been selected to design a prototype of a contraption that can be used to help solve one of the ocean’s problems relating to floating garbage. You may use several simple machines to design a contraption that will collect garbage in the ocean, or you may design and build

a contraption that finds floating garbage in the surf, coastal or intertidal zones. Currently collecting garbage from water systems is typically done by picking up waste once it has been washed up on shore. Thinking creatively, your team might design a device that can collect waste from the water.

## SUCCESS DETERMINANTS

- Your design will include at least two simple machines
- Your design will function in a moist environment/water system
- Your design can be used repeatedly
- Your team will utilize the design process to create a product
- Your design will include a detailed drawing
- Your design shows awareness of the life cycle of the product
- Your team will explain the rationale behind the design and purpose of your simple machine
- Your design must be sturdy enough to not fall apart and contribute to the floating garbage

## PARAMETERS

- You can use items from the pantry
- You can use any of the tools that have been provided.
- You can bring items in from home for your group or for the shared pantry
- Your prototype could be a scale version rather than actual size
- Your prototype must be ready to be tested in the water
- Ideally, your prototype can be built using recycled materials

## SUGGESTIONS FOR USE

Originally conceived with grades 5-6 in mind.

*Curriculum links to;*

- forces and mechanical advantage
- common simple and compound machines.

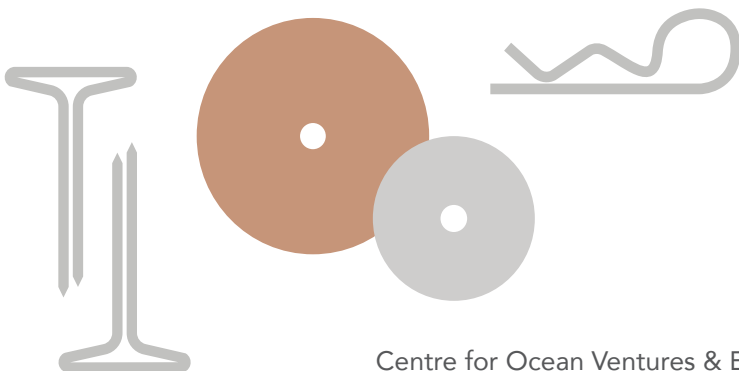

## RESOURCES

1. <https://www.fastcompany.com/40439492/this-11-year-old-invented-a-cheap-test-kit-for-lead-in-drinking-water>
2. <https://www.youtube.com/watch?v=32ndO22BorM>
3. <https://www.nature.com/scitable/knowledge/library/ocean-acidification-25822734> (PH levels and the effects on marine life).
4. <https://www.sciencedaily.com/releases/2011/04/110419111429.htm> (propeller turbulence)



# DESIGN CHALLENGE 9: UNDERWATER EXPLORATION: Designing Underwater DIY Waterproof Cameras

## OVERVIEW

The ocean is a vast resource that covers more than 70% of the earth. Surprisingly, we have only explored at 4% of it! In many ways we know more about outer space than we do about the great ocean that sustains our planet. Have you ever wondered what lies beneath the surface of the ocean? What

amazing plant and animal creatures conduct their lives in the briny sea? For some the unknown can be intimidating. For others, it is thrilling. If you could see what lies beneath the surface of the water, a new world of exploration could be uncovered.

## DESIGN RATIONALE

The ocean can be difficult to observe. Some students may have a fear of the unknown. For others, mobility issues could prevent them from entering a body of water. Allowing students to explore the ocean indirectly may reduce fears of engaging with the ocean environment and take safety into account.

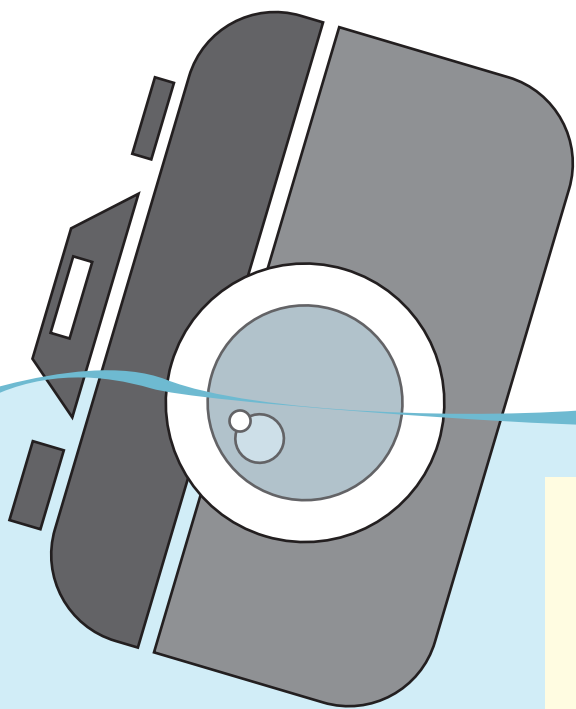

## PROBLEM SCENARIO

Your team has been selected to make a waterproof device that will house a camera and/or video recording device. The device will allow students to explore an underwater environment from dry land. *(An adaptation for physically disabled students would be to design an underwater simulation of a water system through Co-Spaces online software)*



## SUCCESS DETERMINANTS / ASSESSMENT

- Your design must show awareness of materials to create a waterproof/resistant product
- Your design must be compact, lightweight and portable
- Your design must be reusable
- Your design must not interfere with ocean life or leave any kind of 'footprint'
- Your camera/recording Device must be stable on the inside – we don't want it to fall out and add to the garbage in the ocean
- Your design should allow all students to manoeuvre the camera to adjust view
- Your design may optionally include the ability to record (video and or photo)

## PARAMETERS

- You can use items from the pantry
- You can use any of the tools that have been provided.
- You can bring items in from home for your group or for the shared pantry
- Your prototype must be ready to be tested in the water
- Ideally, your prototype can be built using recycled materials
- Your prototype will be no bigger than 20 cm X 20cm X 20 cm, and under 1000grams in weight
- Your prototype must achieve "neutral buoyancy".
- Your prototype must be built within an assigned budget, e.g. \$20 (not including the Camera and video recording devices e.g. Go Pro or other model, Raspberry Pi 2 or 3, Arduino, and/or a disposable waterproof digital camera, etc...)

## RESOURCES

1. [https://www.juliantrubin.com/encyclopedia/engineering/waterproof\\_camera.html](https://www.juliantrubin.com/encyclopedia/engineering/waterproof_camera.html)
2. <https://diy.org/skills/oceanographer/challenges/482/build-a-waterproof-camera-case>
3. <https://makezine.com/2008/02/27/diy-waterproof-camera-enc/>
4. <https://cospaces.io/edu/> - Virtual Reality and Augmented Reality design software
5. <https://www.chasingcoral.com/> - example of DIY camera design in the real world.

## SUGGESTIONS FOR USE

Originally conceived with grades 5-6 in mind.

*Curriculum links to;*

- communication (critical dialogue)
- creativity and innovation
- critical thinking
- technological fluency

# DESIGN CHALLENGE 10: OCEAN DESIGN CHALLENGE

## OVERVIEW

Shipping worldwide is a way of life. In fact, roughly 90 percent of dry, non-bulk manufactured goods are shipped in ocean containers. This includes machine parts, electronics, paper, tires, footwear, scrap metal, clothes, auto parts, toys, food, beverages, chemicals, textiles, furniture, and appliances. Often containers are lost during rough sea voyages. Weather systems and currents are important to understand for the best planning and delivery of shipped goods.

## DESIGN RATIONALE

Container ships represent feats of engineering, as they must be designed for great capacity (*be able to carry enormous loads*), buoyancy (*be able to float in ocean waters at different temperatures and with different loads*), and stability (*remain stable whether the seas are calm or stormy*).



## PROBLEM SCENARIO

You are part of a Ship Building Company that has been hired to redesign Cargo Ships. The goal is to have 0% loss of shipped materials. You need to design a container ship that will not lose its cargo during its voyage, but be strong and stable enough to handle the weather and water of an Atlantic Ocean voyage from Halifax to Argentina.

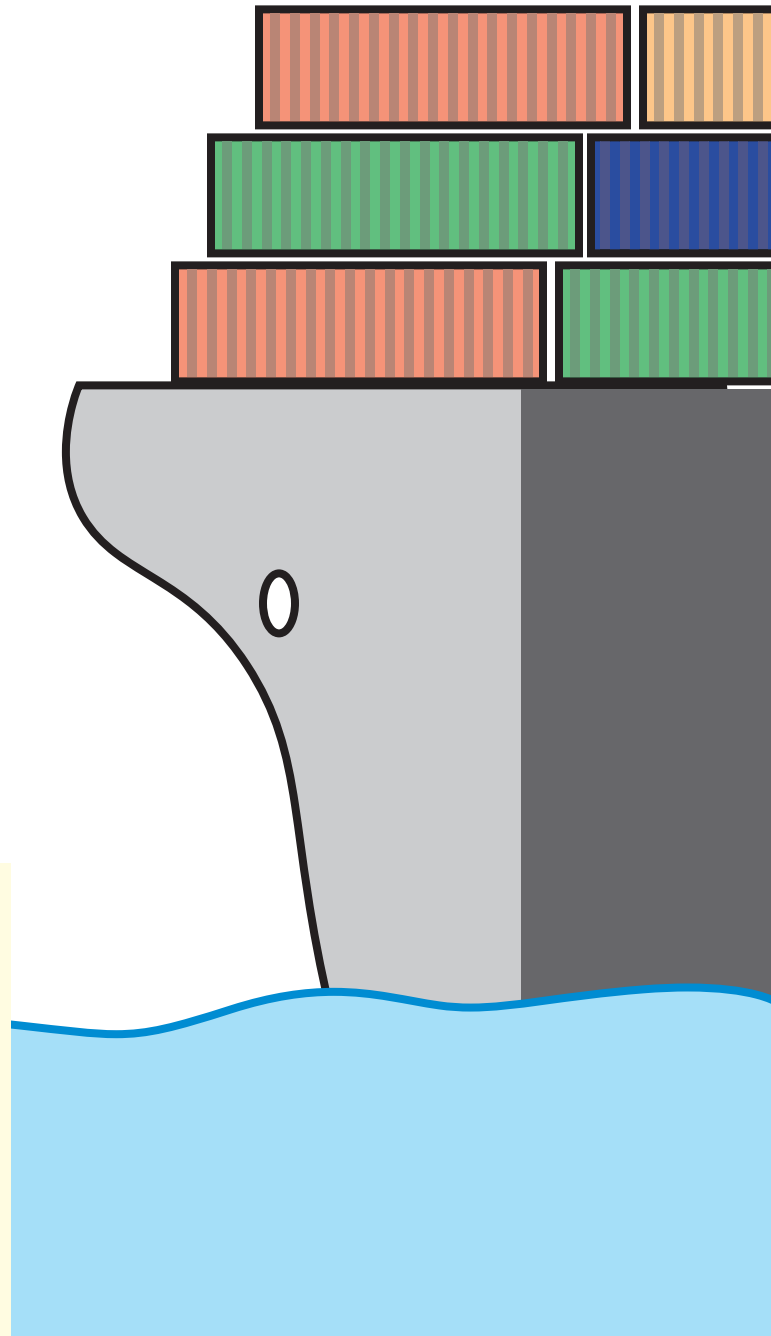



## SUCCESS DETERMINANTS

The boat can stay afloat in a variety of circumstances:

- Your design can stay afloat in different situations and weather simulations (i.e. still water, blow by hair dryer or strong fan, rock dropped into the water), and with a huge load (add weights)
- Your design shows awareness of properties relating to buoyancy and stability
- Your design shows awareness of the properties of marine water

## PARAMETERS

- You can use items from the pantry
- You can use any of the tools that have been provided.
- You can bring items in from home for your group or for the shared pantry
- Your prototype must be ready to be tested in the water
- Ideally, your prototype can be built using recycled materials
- Your prototype will not exceed 900 cm<sup>2</sup>
- Your prototype will be able to hold a minimum of 1000g (or some non-standard unit of measure)

## RECOMMENDED MATERIALS

- Plasticine, Model Magic
- Plastic water/pop/juice bottles, old plastic duotangs or report covers
- Balsa wood, straws, popsicle sticks for framing
- Cardboard & water proofing options (plastic wrap, tin foil, etc)
- Crafting/decorating materials
- Duct tape, glue sticks, silicone

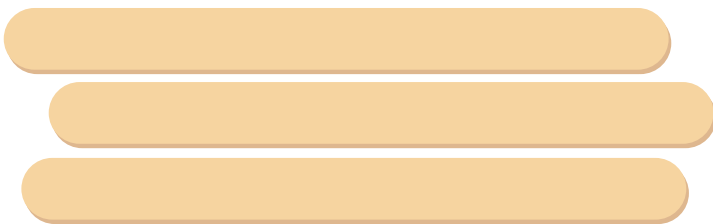

## OCEAN DESIGN CHALLENGE cont.

### RESOURCES

1. Lego Spill Today - <https://www.bbc.com/news/magazine-28367198>
2. Why The Lego Spill Happened - <https://www.theatlantic.com/technology/archive/2014/07/why-are-all-these-legos-washing-up-on-the-beach/374739/>
3. Moby Duck - <https://www.mnn.com/earth-matters/wilderness-resources/stories/what-can-28000-rubber-duckies-lost-at-sea-teach-us-about>



### SUGGESTIONS FOR USE

Originally conceived with grades 5-6 in mind.

*Curriculum links to;*

- communication (*critical dialogue*)
- creativity and innovation
- critical thinking
- technological fluency
- math (*surface area, volume*)
- science (*weather, currents*)
- social sciences (*how environment influences humans*)
- economy (*how shipping by water/air/rail relates to the cost of products we buy*)

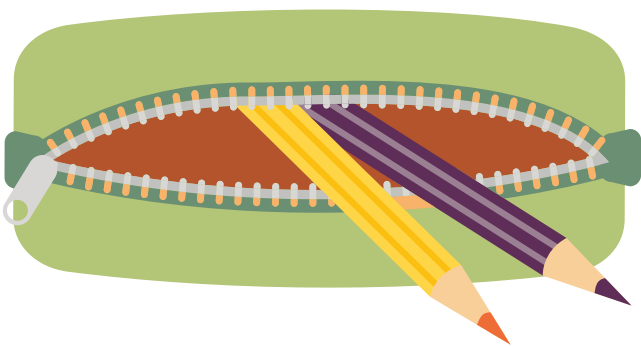

## SKILL-BUILDING ACTIVITY: BUILDING A SHIP'S HULL



### SKILL-BUILDING ACTIVITIES

This activity is designed with inverted outcomes from the previous Maker activities. Where the other activities are designed to inspire divergent and creative thinking, resulting in infinite different ideas and designs – with none the same - this activity is designed to build and refine skills related to interpreting a design where the final products should all be the same or similar. This activity mimics advanced manufacturing processes where precision is essential. With an emphasis on skills related to engineering and trades, this activity taps into a different area of ability and competency relating to reading, attention to detail, precision measuring and cutting, structured collaboration and teamwork, process and structure, and interpreting a 3-D object from a 2-D illustration.

### OVERVIEW

Shipbuilding is a team effort at Irving Shipbuilding's Halifax Shipyard. It requires focus, precision, communication and cooperation from shipbuilders in many different roles working together to build the Royal Canadian Navy's future fleet.

Using some of the latest technology, combined with traditional manufacturing, welders, pipe-fitters, electricians, designers, engineers, quality inspectors, accountants, supply chain managers, and many more are working together every day to maintain and repair Halifax Class frigates, and build new Arctic and Offshore Patrol Ships, and Canadian Surface Combatants.



## SKILL-BUILDING ACTIVITY: BUILDING A SHIP'S HULL cont.

We encourage you to visit [shipsforcanada.ca](http://shipsforcanada.ca) to show your class updated videos of the latest progress at Halifax Shipyard.

### DESIGN RATIONALE

The design of this workshop is to combine technical skill building (*mimicking metal fabrication and welding*) with literacy (*authentic document use*) and engineering (*assembly of parts into a whole with integrity*) as students participate in a collaborative build project that simulates advanced manufacturing and materials management in a modern shipbuilding facility. The purpose of this workshop is for each student to have the same product at the end. Where other activities encourage creativity, this workshop encourages students to go through a specific process, follow directions and coming up with the intended end product.

### THIS ACTIVITY INVOLVES:

- *reading authentic blue-prints (designed by a team of engineers from Irving Shipbuilding Inc),*
- *material cutting and shaping (to mimic metal fabrication),*
- *gluing (to mimic welding), and assembly of mega-blocks into a ship's hull.*



### PROBLEM SCENARIO

#### BUILDING CANADA'S NEXT FLEET

The government has issued a contract for Canadian Ships to be built for the Royal Canadian Navy. In order to be the most efficient with the budget, these ships need to be exactly the same and precisely built. These ships need to be completed to the best quality (water tight, stable) in the shortest amount of time with the least amount of waste. Teams are encouraged to decide how best to tackle this project – by assigning discreet tasks to each individual (i.e. cutter, welder/gluer, project manager, quality control person, blue-print reader, etc), or by each individual assuming all of these roles for a single section of the ship. You will be required to track your progress, your costs and note any waste during construction.

This activity has strong curricular connections with Technology education, reading and interpreting technical drawings, translating 2-D drawings into a 3-D model, and investigate connections between technology education, STEM and careers.

## SUCCESS DETERMINANTS

- Students have demonstrated that they have successfully followed the blue prints
- The final product looks the way it is supposed to be designed
- The structure floats
- Students will have to reflect on what they did that worked, what didn't and where improvements can be made.

## PARAMETERS

- Students will be divided into various roles, where they must work together and communicate.
- Students will be given a budget to purchase materials
- Students are to build their structure with the least amount of waste and lowest possible budget. Any waste must be accounted for in the budget
- Students must research how ships are named, and properly name their structure

## ACTIVITY EXTENSIONS

- **Careers.** Have students work in assigned roles throughout the project. Research the different careers and present back on how they contributed to the overall constructions and assembly
- **Project Management.** Include financial management by assigning prices to the materials, and a labour cost (per 30 minutes of labour), and a target budget and build time for students to work towards
- **Functionality.** Once the ship is assembled and launched, have students work to make it stable and balanced and able to carry an assigned load in the hull and on deck. Add requirements for the superstructure or deck use. Design and add a propulsion system.
- **Reverse Engineer.** Build a simple vessel or structure in 'blocks' and then do drawings and work instructions for its construction and assembly. Can be done with uniform materials (i.e. lego) or non-uniform (i.e. recyclables, consumables)





**SC-001 Manufacture and Assembly of the STEM Class Ship**

**Purpose: To Manufacture and Assemble a STEM Class Ship for the Royal Canadian Navy**

**Scope: This Process Applies to the STEM Class Program Only**

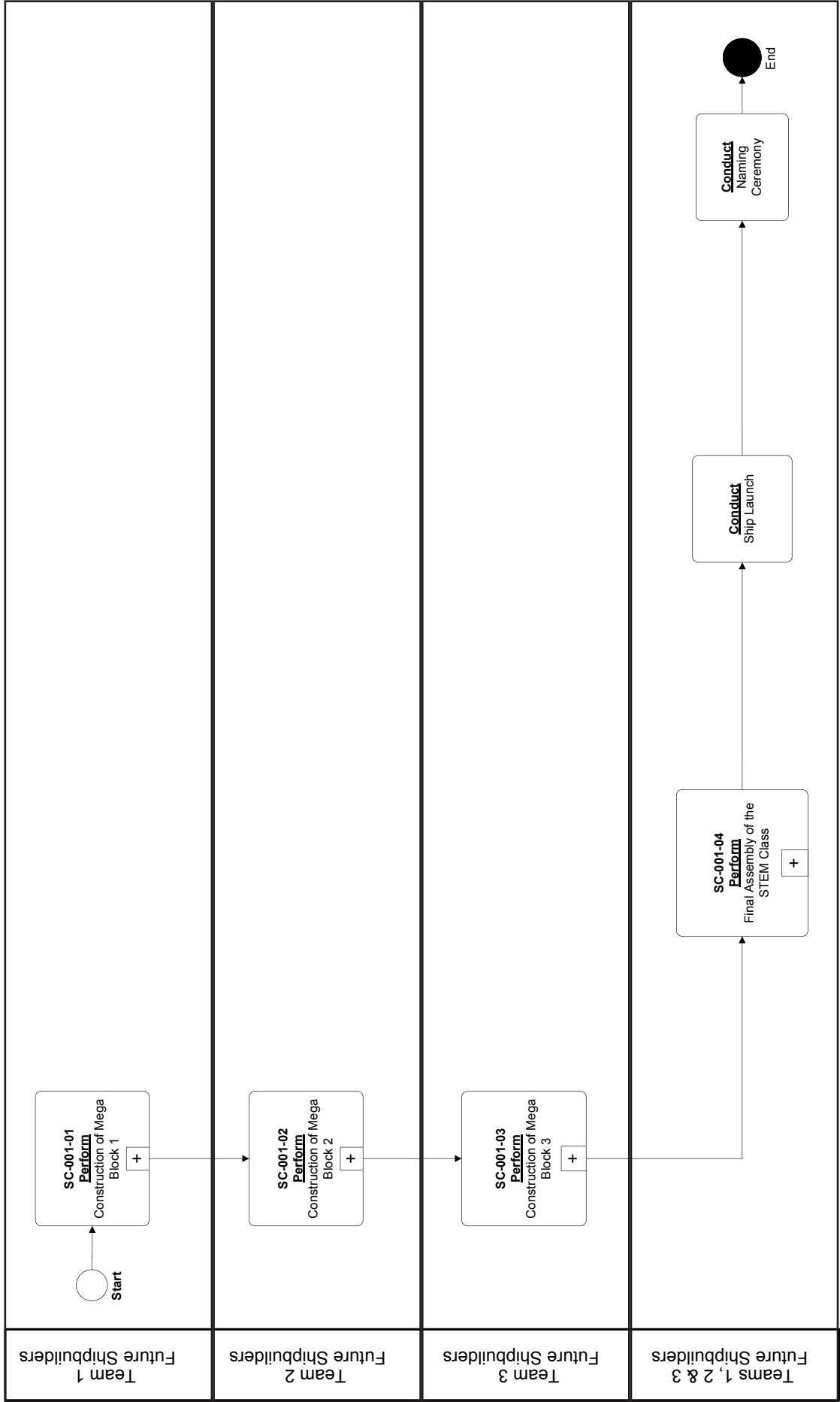

# CONSTRUCTION OF MEGA BLOCK 1

## ACTIVITY

To construct the Stern Section of the STEM Class Ship - Mega Block 1

## NOTES:

- Ensure optimal utilization of all materials to reduce waste.
- Ensure all cutting surfaces are protected when cutting materials with the use of a cutting board.

## MATERIAL REQUIREMENTS:

Sharpie  
Clear Ruler  
Exacto Knife  
Cutting Board  
Foam Board  
Black Plastic Sheets  
Scissors  
Glue Gun  
Canada Flag

## DEFINITIONS AND ACRONYMS:

### Definitions:

**Bulkhead** - A dividing wall or barrier between compartments in a ship

**Deck** - A structure approximately horizontal, extending across a ship

**Longitudinal** - Situated along the length of the ship

**Port** - The left side of the ship

**Shell** - The outer most structure of a ship

**Starboard** - The right side of the ship

**Stern** - The back most part of the ship

**Transverse** - Situated across the width of the ship

### Acronyms:

**DWG** - Drawing

**FWD** - Forward

**LKG FWD** - Looking Forward

**LKG DOWN** - Looking Down

**LKG PORT** - Looking Port

**PS** - Port Side

**STBD** - Starboard

**TYP** - Typical, meaning the same on both sides

## STEPS:

### 1 Stern - Transverse Bulkhead

**1.1** Using Plan 1 (p.66) measure, mark-up and cut out section of Foam Board using an Exacto Knife to the exact measurements stipulated on the drawing.

### 2 Stern – Longitudinal Bulkhead

**2.1** Using Plan 2 (p.67) measure, mark-up and cut out section of Foam Board using an Exacto Knife to the exact measurements stipulated on the drawing.

### 3 Stern – Deck

**3.1** Using Plan 3 (p.68) measure, mark-up and cut out section of Foam Board using an Exacto Knife to the exact measurements stipulated on the drawing.

### 4 Stern - Shell

**4.1** Using Plan 4 (p.69) follow the 'NOTES' section to mark-up, cut and fold Black Plastic Paper using Scissors to the exact measurements stipulated on the drawing.

### 5 Stern – Assembly

**5.1** Using Plan 5 (p.70) follow the 'NOTES' section to assemble Transverse Bulkhead, Longitudinal Bulkhead, Deck & Shell to form Mega Block 1.

**5.2** Use glue gun to secure sections.

### 6 Mast Assembly

**6.1** Using Plan 6 (p.71) measure, mark-up and cut Black Plastic Paper using Scissors to the exact measurements stipulated on the drawing.

**6.2** Follow the 'NOTES' section to create the circular section of the Mast.

**6.3** Assemble as per drawing and use glue gun to secure.

**6.4** Install Flag as per drawing.

BILL OF MATERIALS		
NAME	QUANTITY	MATERIAL DESCRIPTION
STERN - TRANSVERSE BULKHEAD	1	0.5CM THICK FOAM BOARD

NOTES:

- 1. ALL DIMENSIONS IN CENTIMETERS
- \*DRAWING NOT TO SCALE

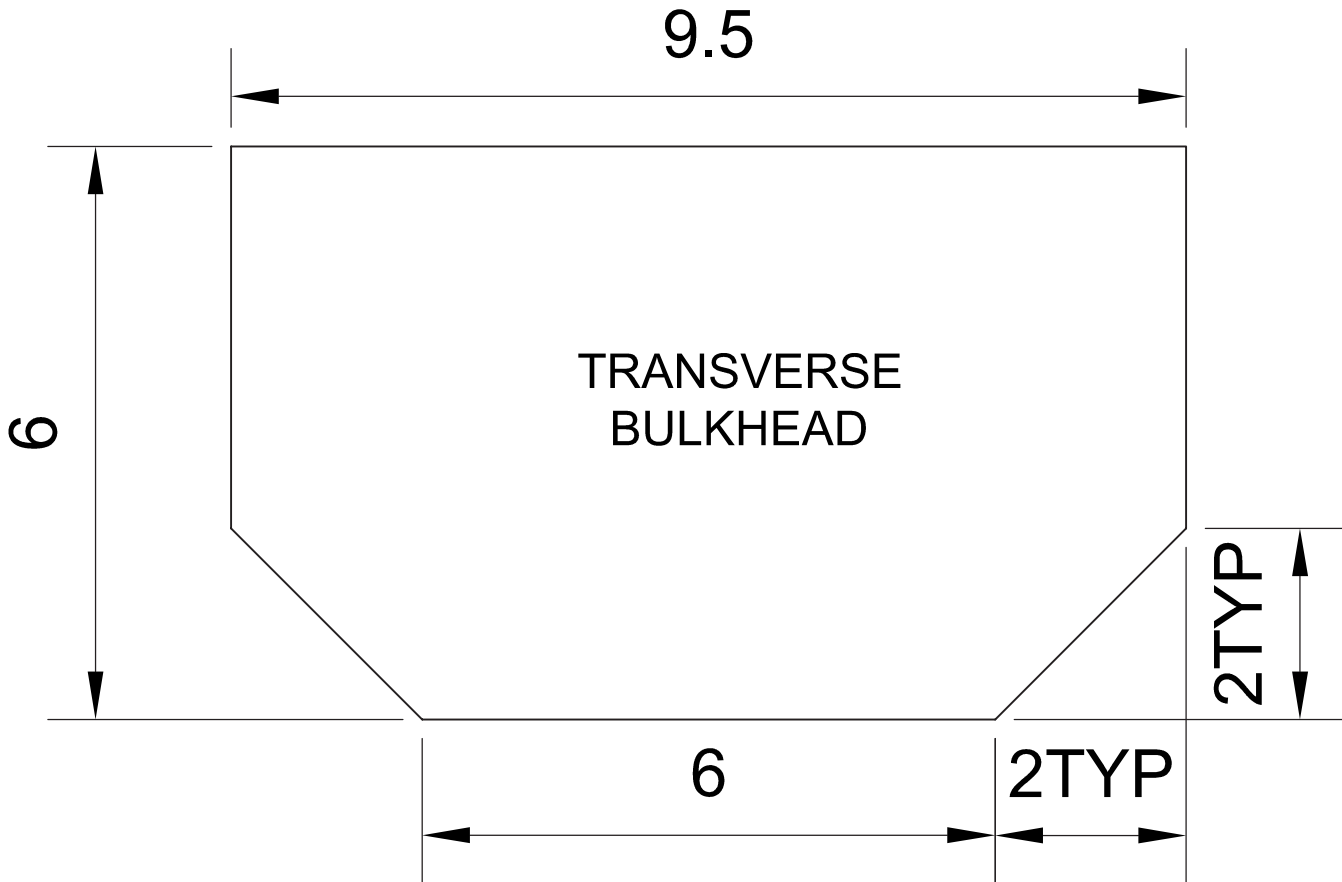

SECTION  
LKG FWD

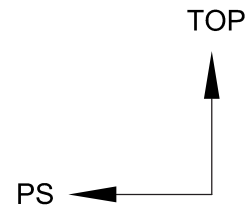

 <b>STEM CLASS</b>  <b>SHIP 1</b>	FABRICATION DRAWING			
	STERN - TRANSVERSE BULKHEAD			
	MEGA BLOCK 1			
	DWN	K. JACKMAN	CHK	C. BANKS
	UNITS	MILLIMETERS	SCALE	NTSD
SHEET	1	DATE	2018-10-29	
DWG NO	A01-STERN PACKAGE-001		REV	A

© IRVING SHIPBUILDING INC. ALL RIGHTS RESERVED

BILL OF MATERIALS		
NAME	QUANTITY	MATERIAL DESCRIPTION
STERN - LONGITUDINAL BULKHEAD	1	0.5CM THICK FOAM BOARD

NOTES:  
 1. ALL DIMENSIONS IN CENTIMETERS  
 \*DRAWING NOT TO SCALE

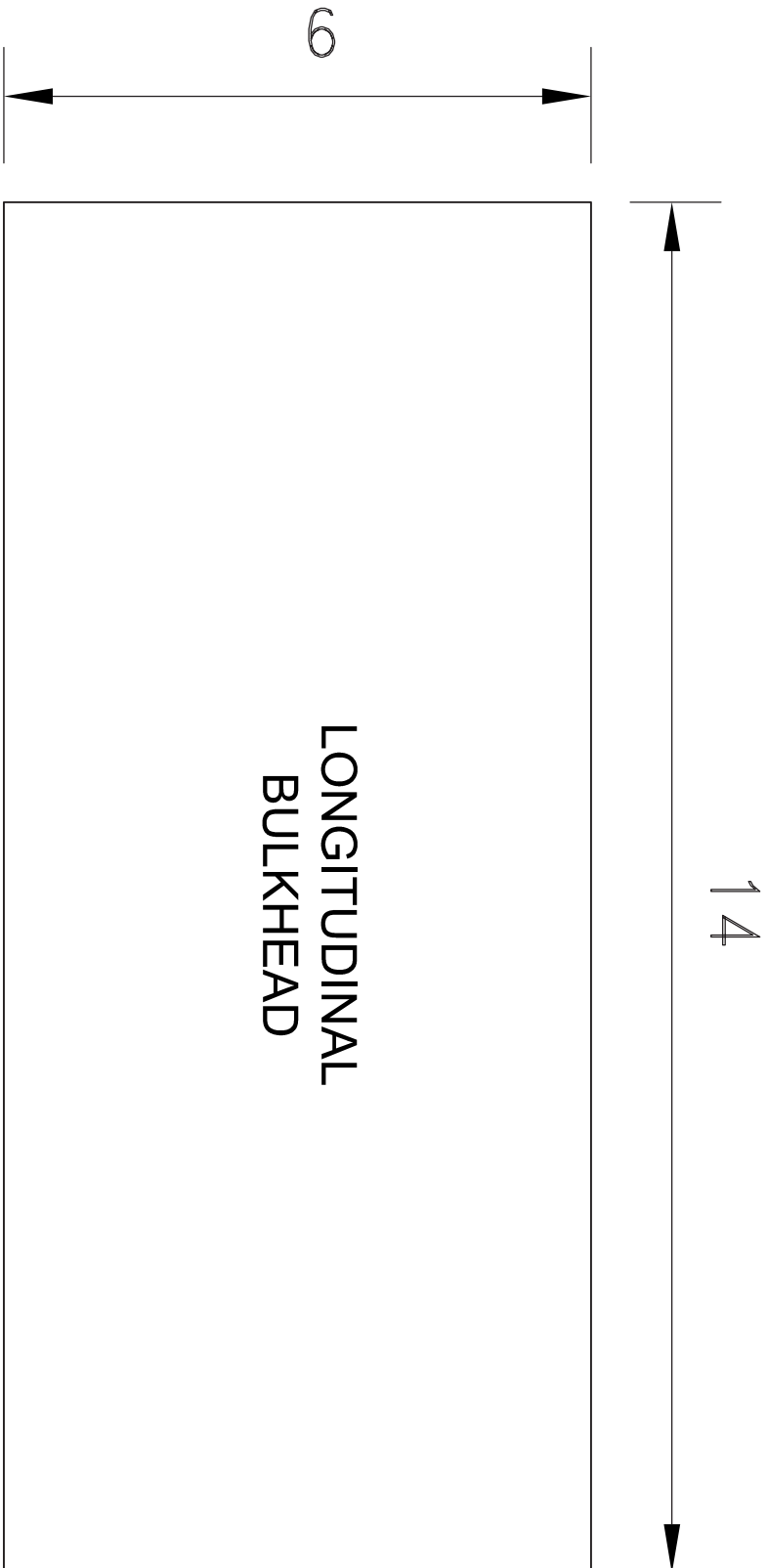

**SECTION**  
LKG PORT

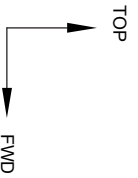

 <small>IRVING Shipbuilding Inc.</small>	<b>FABRICATION DRAWING</b> <b>STERN - LONGITUDINAL BULKHEAD</b> <b>MEGA BLOCK - 1</b>			
	<small>OWN</small> <small>UNITS</small> <small>SHEET</small>	<small>K. JACKMAN</small> <small>MILLIMETERS</small> <small>1</small>	<small>C.BANKS</small> <small>SCALE</small> <small>DATE</small>	<small>NTS</small> <small>2018-10-29</small>
<small>SHIP 1</small>	<small>DWG NO</small> <small>A01-STERN PACKAGE-002A</small>	<small>REV</small>		



BILL OF MATERIALS		
NAME	QUANTITY	MATERIAL DESCRIPTION
STERN - DECK	1	0.5CM THICK FOAM BOARD

NOTES:  
 1. ALL DIMENSIONS IN CENTIMETERS  
 \*DRAWING NOT TO SCALE

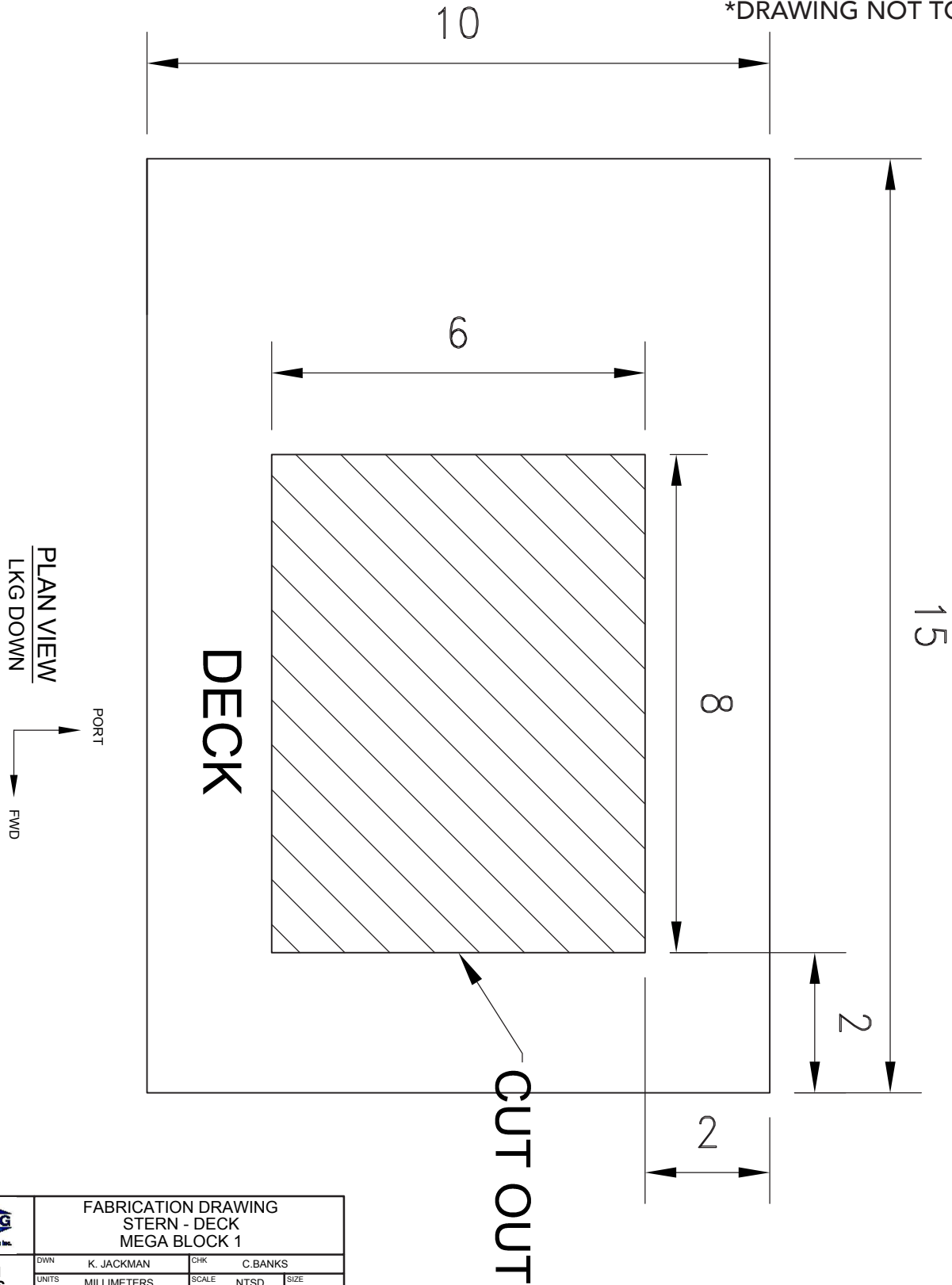

 IRVING Shipbuilding Inc.	FABRICATION DRAWING STERN - DECK MEGA BLOCK 1			
	DWN	K. JACKMAN	CHK	C. BANKS
	UNITS	MILLIMETERS	SCALE	NTSD
	SHEET	1	DATE	2018-10-29
SHIP 1	DWG NO	A01-STERN PACKAGE-003	REV	A

© IRVING SHIPBUILDING INC. ALL RIGHTS RESERVED

BILL OF MATERIALS		
NAME	QUANTITY	MATERIAL DESCRIPTION
STERN - SHELL	1	21.5X28CM BLACK PLASTIC PAPER

- NOTES:**
1. ALL DIMENSIONS IN CENTIMETERS
  2. FIRST DRAW ALL THE FOLD LINES AS SHOWN IN PLAN VIEW 1, DO NOT FOLD YET.
  3. CUT ALONG THE LINES SHOWN IN PLAN VIEW 2.
  4. MARK AN X IN THE CENTER OF THE THREE END SECTIONS.
  5. FOLD ALONG THE FOLD LINES.
  6. BRING THE END SECTIONS TOGETHER SO THAT THE X'S ALL OVERLAP, WITH THE MIDDLE SECTION ON THE INSIDE.

**\*DRAWINGS NOT TO SCALE**

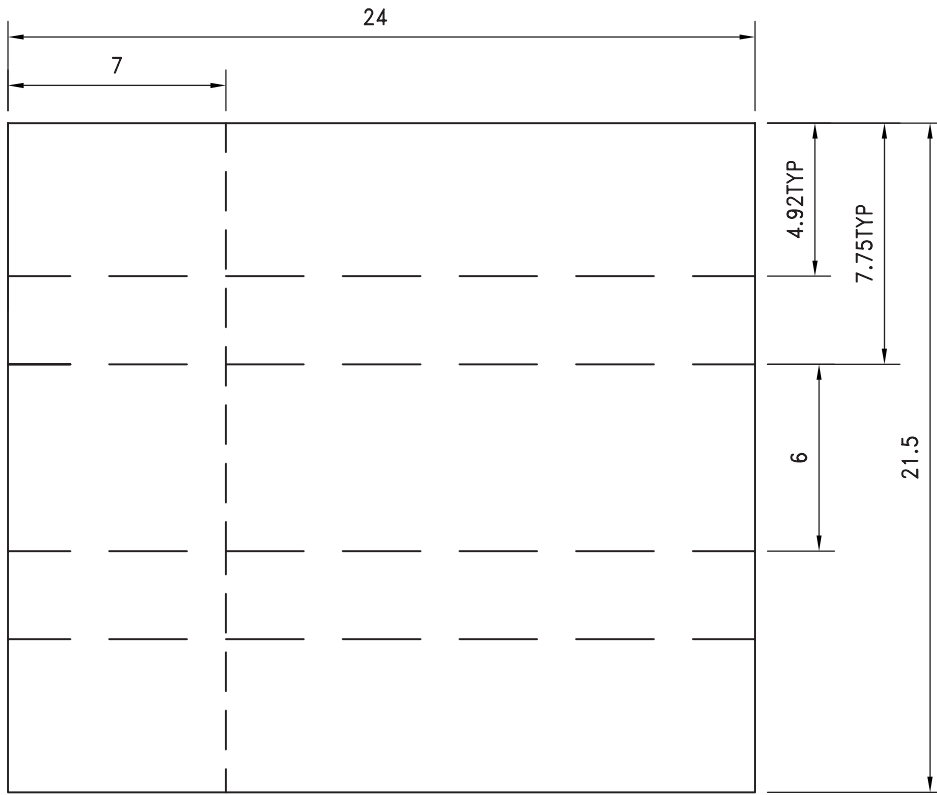

**PLAN VIEW 1**  
LKG DOWN

PORT ↑  
FWD →

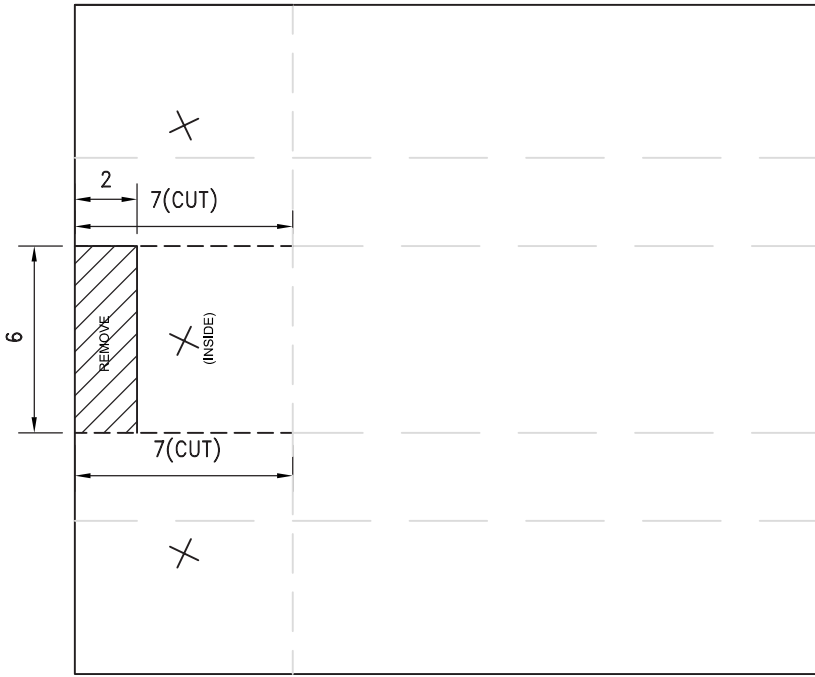

**PLAN VIEW 2**  
LKG DOWN

PORT ↑  
FWD →

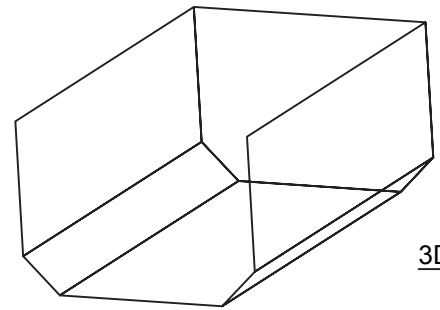

**3D VIEW**

 <b>STEM CLASS</b> <b>SHIP 1</b>	<b>FABRICATION DRAWING</b> <b>STERN - SHELL</b> <b>MEGA BLOCK 1</b>				
	DWN	K. JACKMAN	CHK	C.BANKS	
	UNITS	MILLIMETERS	SCALE	NTSD	SIZE
	SHEET	1	DATE	2018-10-29	REV
DWG NO	A01-STERN PACKAGE-004A			REV	

© IRVING SHIPBUILDING INC. ALL RIGHTS RESERVED

PARTS LIST	
NAME	QUANTITY
STERN - SHELL	1
STERN - LONGITUDINAL BULKHEAD	1
STERN- TRANSVERSE BULKHEAD	1
STERN - DECK	1

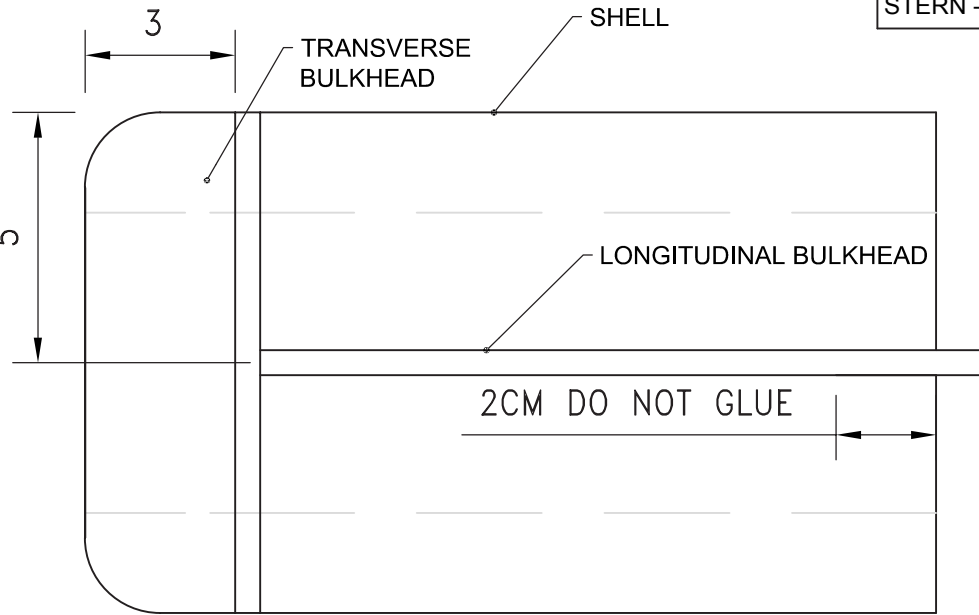

**PLAN VIEW 1**  
LKG DOWN  
BULKHEAD INSTALLATION

PORT ↑  
FWD →

**NOTES:**

1. ALL DIMENSIONS IN CENTIMETERS
2. INSTALL TRANSVERSE AND LONGITUDINAL BULKHEADS ONTO THE SHELL AS SHOWN IN PLAN VIEW 1.
3. INSTALL DECK ON TOP AS SHOWN IN PLAN VIEW 2.

**\*DRAWINGS NOT TO SCALE**

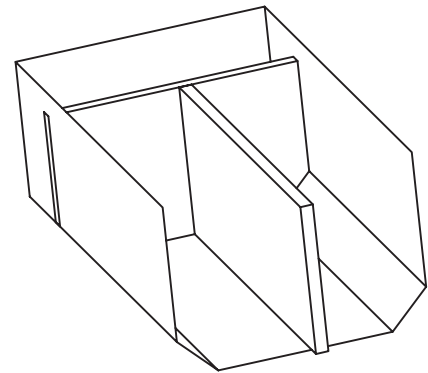

**3D VIEW**  
(DECK NOT SHOWN FOR CLARITY)

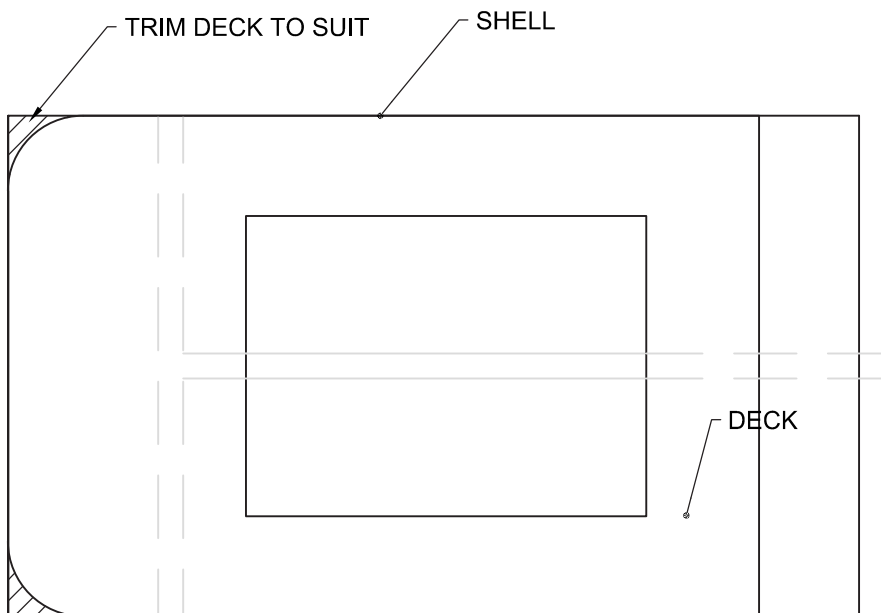

**PLAN VIEW 2**  
LKG DOWN  
DECK INSTALLATION

PORT ↑  
FWD →

IRVING <small>Irving Shipbuilding Inc.</small>		ASSEMBLY DRAWING STERN ASSEMBLY MEGA BLOCK 1		
<b>STEM CLASS</b>	DWN	K. JACKMAN	CHK	C.BANKS
	UNITS	MILLIMETERS	SCALE	NTS SIZE D
<b>SHIP 1</b>	SHEET	1	DATE	2018-10-29
	DWG NO	A01-STERN PACKAGE-005		REV A

BILL OF MATERIALS		
NAME	QUANTITY	MATERIAL DESCRIPTION
MAST	1	21.5X28CM BLACK PLASTIC PAPER

**NOTES:**

1. ALL DIMENSIONS IN CENTIMETERS
2. ROLL THE PAPER OVERLAPPING THE BLACK DOTS.
3. USE ROLLED PAPER TO TRACE A CIRCLE FOR THE TOP.
4. INSTALL FLAG ON TOP.

**\*DRAWINGS NOT TO SCALE**

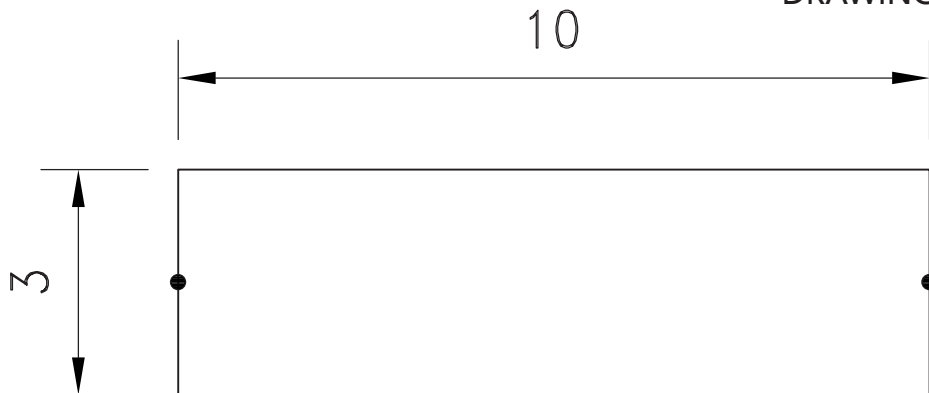

**SECTION 1**  
**LKG PORT**

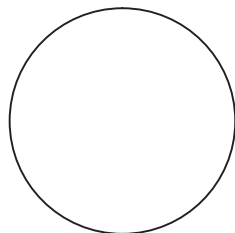
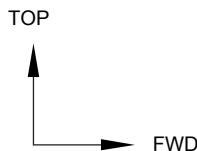

**PLAN VIEW**  
**LKG DOWN**

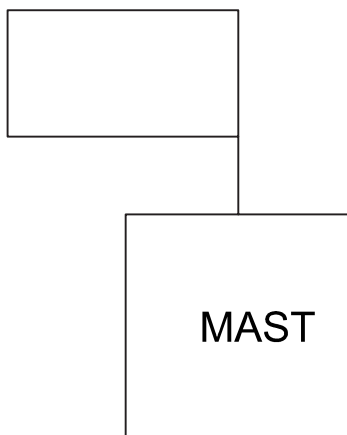
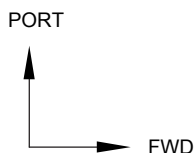

**SECTION 2**  
**LKG PORT**

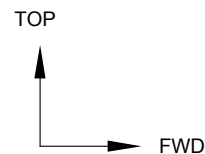

 <b>STEM CLASS</b>  <b>SHIP 1</b>	ASSEMBLY DRAWING MAST ASSEMBLY			
	DWN	K. JACKMAN	CHK	C. BANKS
	UNITS	MILLIMETERS	SCALE	NTS
	SHEET	1	DATE	2018-10-29
	DWG NO	A01-STERN PACKAGE-006	REV	A

© IRVING SHIPBUILDING INC. ALL RIGHTS RESERVED

# CONSTRUCTION OF MEGA BLOCK 2

## ACTIVITY

To Construct Midship Section of a STEM Class Ship – Mega Block 2.

## NOTES:

- Ensure optimal utilization of all materials to reduce waste.
- Ensure all cutting surfaces are protected when cutting materials with the use of a cutting board.
- Take note of the quantity required within the bill of materials section of the drawing attachments.

## MATERIAL REQUIREMENTS:

Sharpie  
Clear Ruler  
Exacto Knife  
Cutting Board  
Foam Board  
Black Plastic Sheets  
Scissors  
Glue Gun

## DEFINITIONS AND ACRONYMS:

### Definitions:

**Bulkhead** - A dividing wall or barrier between compartments in a ship

**Deck** – A structure approximately horizontal, extending across a ship

**Longitudinal** – Situated along the length of the ship

**Port** - The left side of the ship

**Shell** - The outer most structure of a ship

**Starboard** – The right side of the ship

**Stern** - The back most part of the ship

**Transverse** - Situated across the width of the ship

### Acronyms:

**DWG** - Drawing

**FWD** - Forward

**LKG FWD** - Looking Forward

**LKG DOWN** – Looking Down

**LKG PORT** – Looking Port

**PS** – Port Side

**STBD** – Starboard

**TYP** - Typical, meaning the same on both sides

## STEPS:

### 1 Midship – Transverse Bulkhead

**1.1** Using Plan 1 (p.73) measure, mark-up and cut out section of Foam Board using an Exacto Knife to the exact measurements stipulated on the drawing.

**1.2** Repeat step 1.1 to create a second Transverse Bulkhead section.

### 2 Midship – Longitudinal Bulkhead

**2.1** Using Plan 2 (p.74) measure, mark-up and cut out section of Foam Board using an Exacto Knife to the exact measurements stipulated on the drawing.

### 3 Midship – Deck

**3.1** Using Plan 3 (p.75) measure, mark-up and cut out section of Foam Board using an Exacto Knife to the exact measurements stipulated on the drawing.

### 4 Midship - Shell

**4.1** Using Plan 4 (p.76) measure, mark-up and cut out section of Black Plastic Paper using Scissors, to the exact measurements stipulated on the drawing.

**4.2** Measure, mark-up and fold section of Black Plastic Paper to exact measurements stipulated on the drawing to form the shape indicated.

### 5. Midship - Assembly

**5.2** Using Plan 5 (p.77) follow the 'NOTES' section to assemble Transverse Bulkhead, Longitudinal Bulkhead, Deck & Shell to form Mega Block 2.

**5.3** Use glue gun to secure sections.

### 6 Superstructure Assembly

**6.1** Using Plan 6 (p.78) measure, mark-up and cut Black Plastic Paper using Scissors to the exact measurements stipulated on the drawing.

**6.2** Follow the 'NOTES' section to form the structure indicated on the drawing.

**6.3** Use glue gun to secure.

BILL OF MATERIALS		
NAME	QUANTITY	MATERIAL DESCRIPTION
MIDSHIP - TRANSVERSE BULKHEAD	2	0.5CM THICK FOAM BOARD

NOTES:  
 1. ALL DIMENSIONS IN CENTIMETERS  
 \*DRAWING NOT TO SCALE

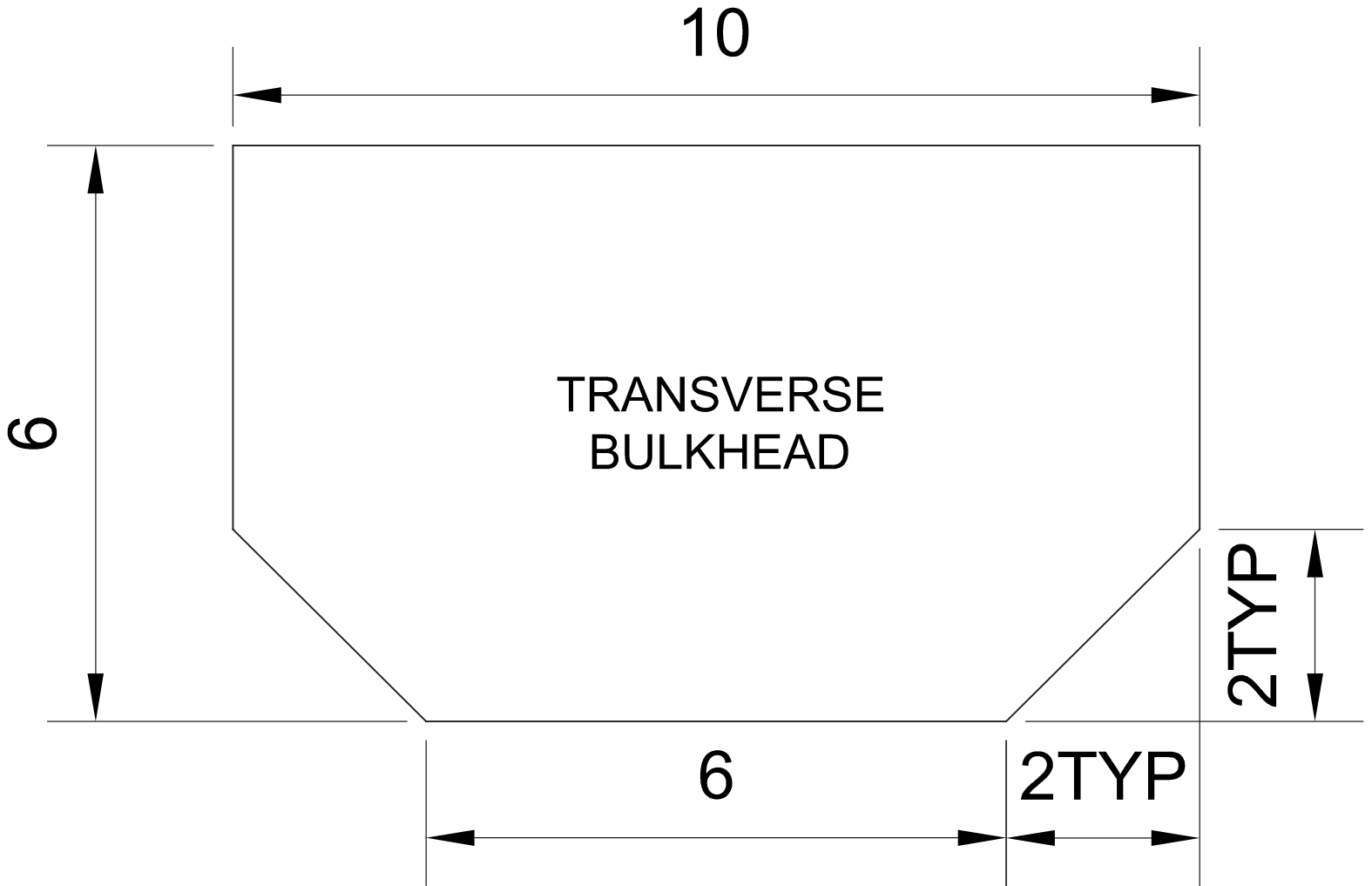

**SECTION  
LKG FWD**

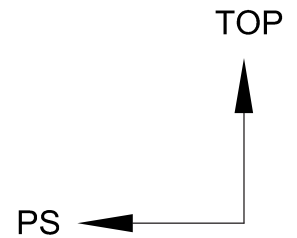

 <b>STEM CLASS</b>  <b>SHIP 1</b>	FABRICATION DRAWING			
	MIDSHIP - TRANSVERSE BULKHEAD			
	MEGA BLOCK 2			
	DWN	K. JACKMAN	CHK	C.BANKS
	UNITS	MILLIMETERS	SCALE	NTSD
SHEET	1	DATE	2018-10-29	
DWG NO	A01-MIDSHIP PACKAGE-001		REV	A

© IRVING SHIPBUILDING INC. ALL RIGHTS RESERVED



**BILL OF MATERIALS**

NAME	QUANTITY	MATERIAL DESCRIPTION
MIDSHIP - LONGITUDINAL BULKHEAD	1	0.5CM THICK FOAM BOARD

**NOTES:**

- 1. ALL DIMENSIONS IN CENTIMETERS
- \*DRAWING NOT TO SCALE



 IRVING Shipbuilding Inc.	FABRICATION DRAWING MIDSHIP-LONGITUDINAL BULKHEAD MEGA BLOCK 2			
	DWN	K. JACKMAN	CHK	C. BANKS
	UNITS	MILLIMETERS	SCALE	NTSD
	SHEET	1	DATE	2018-10-29
	SHIP 1	DWG NO	A01-MIDSHIP PACKAGE-002A	REV

© IRVING SHIPBUILDING INC. ALL RIGHTS RESERVED

BILL OF MATERIALS		
NAME	QUANTITY	MATERIAL DESCRIPTION
MIDSHIP - DECK	1	0.5CM THICK FOAM BOARD

**NOTES:**

- 1. ALL DIMENSIONS IN CENTIMETERS
- \*DRAWING NOT TO SCALE

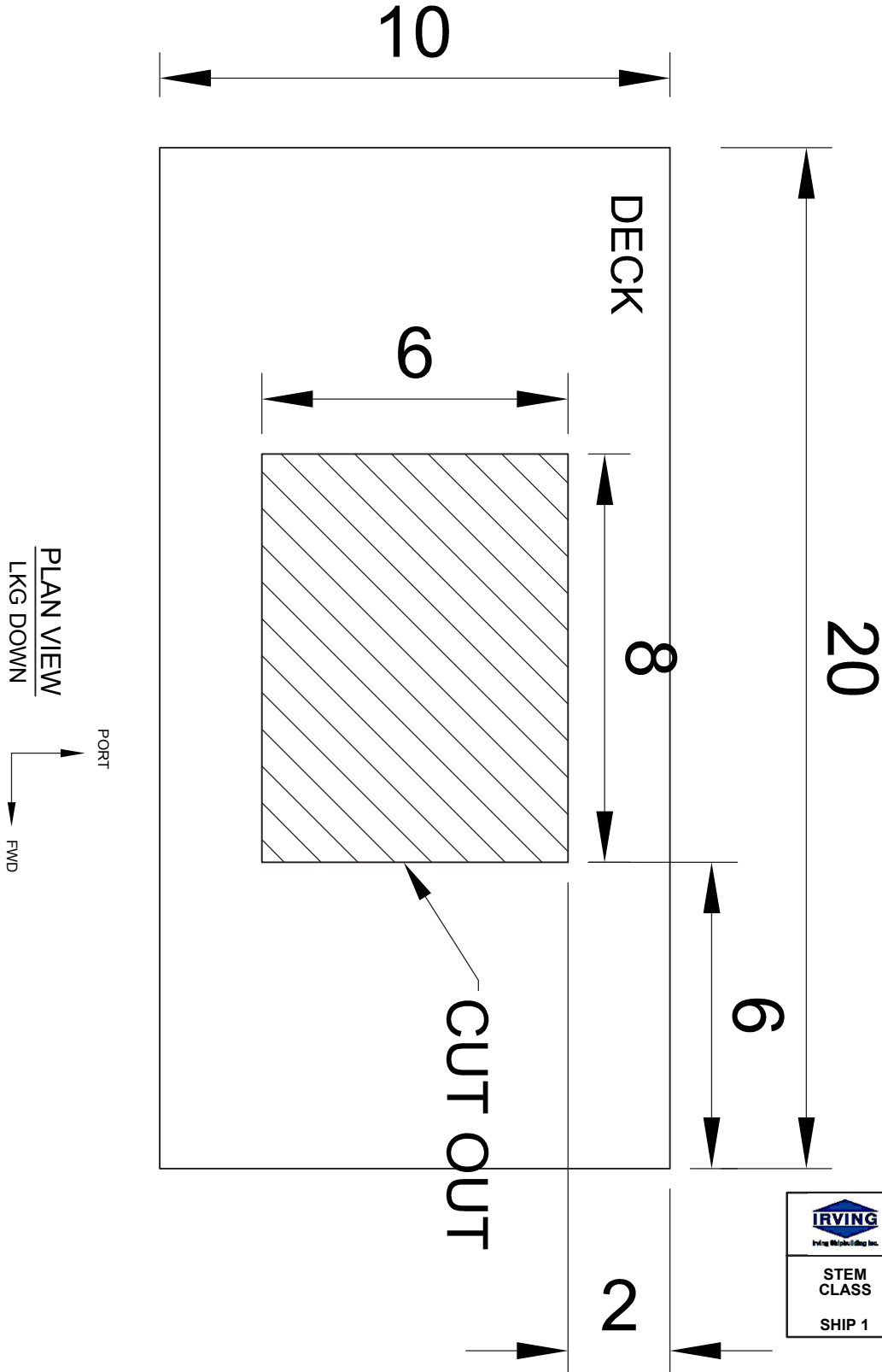

BILL OF MATERIALS		
NAME	QUANTITY	MATERIAL DESCRIPTION
MIDSHIP - SHELL1		21.5X28CM BLACK PLASTIC PAPER

NOTES:

1. ALL DIMENSIONS IN CENTIMETERS
2. DRAW AND FOLD ALONG FOLD LINES.

\*DRAWING NOT TO SCALE

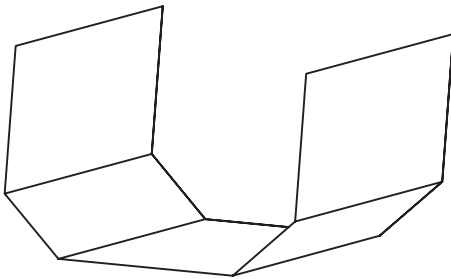
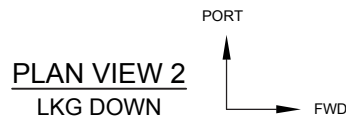
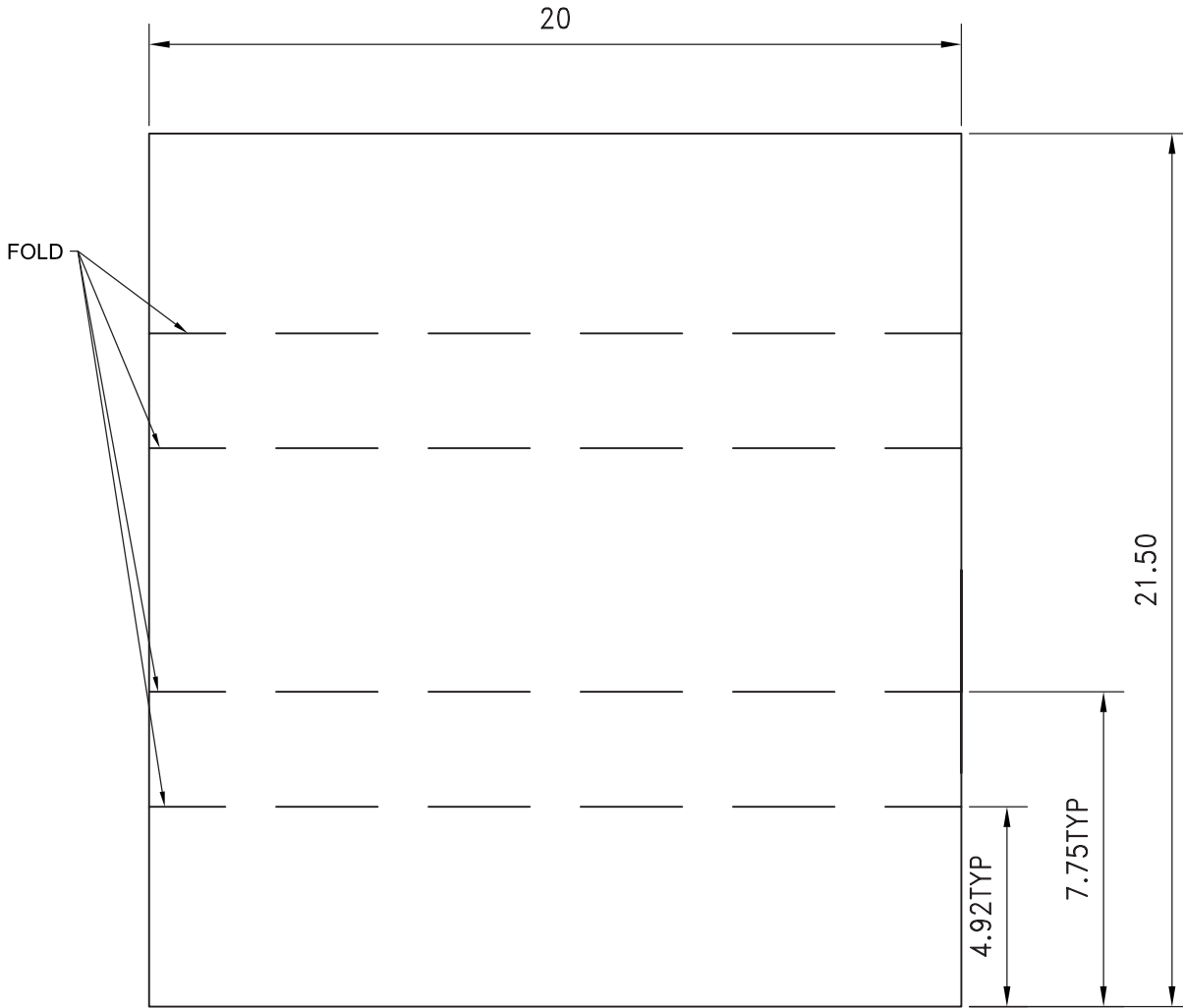

3D VIEW

 <b>STEM CLASS</b>  <b>SHIP 1</b>	FABRICATION DRAWING MIDSHIP-SHELL MEGA BLOCK 2			
	DWN	K. JACKMAN	CHK	C. BANKS
	UNITS	MILLIMETERS	SCALE	TS    SIZE    D
	SHEET	1	DATE	2018-10-29
	DWG NO	A01-MIDSHIP PACKAGE-004		REV    A

© IRVING SHIPBUILDING INC. ALL RIGHTS RESERVED

PARTS LIST	
NAME	QUANTITY
MIDSHIP - SHELL1	
MIDSHIP - LONGITUDINAL BULKHEAD	1
MIDSHIP - TRANSVERSE BULKHEAD	2
MIDSHIP - DECK	1

**NOTES:**

1. ALL DIMENSIONS IN CENTIMETERS
2. INSTALL TRANSVERSE AND LONGITUDINAL BULKHEADS ONTO THE SHELL AS SHOWN IN PLAN VIEW 1.
3. INSTALL DECK ON TOP AS SHOWN IN PLAN VIEW 2.

**\*DRAWING NOT TO SCALE**

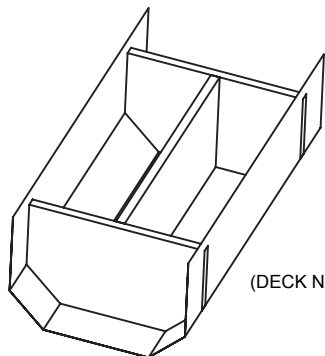
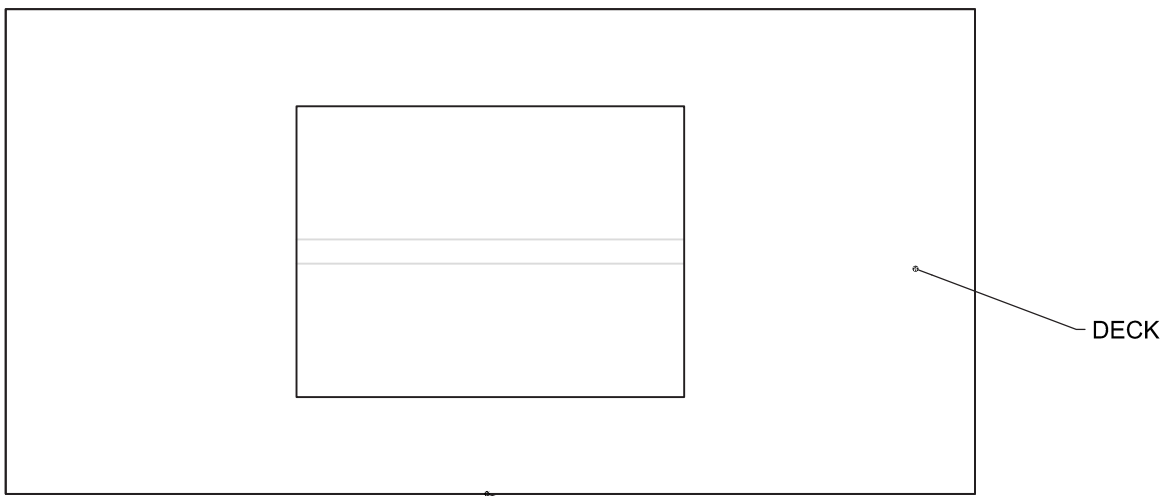
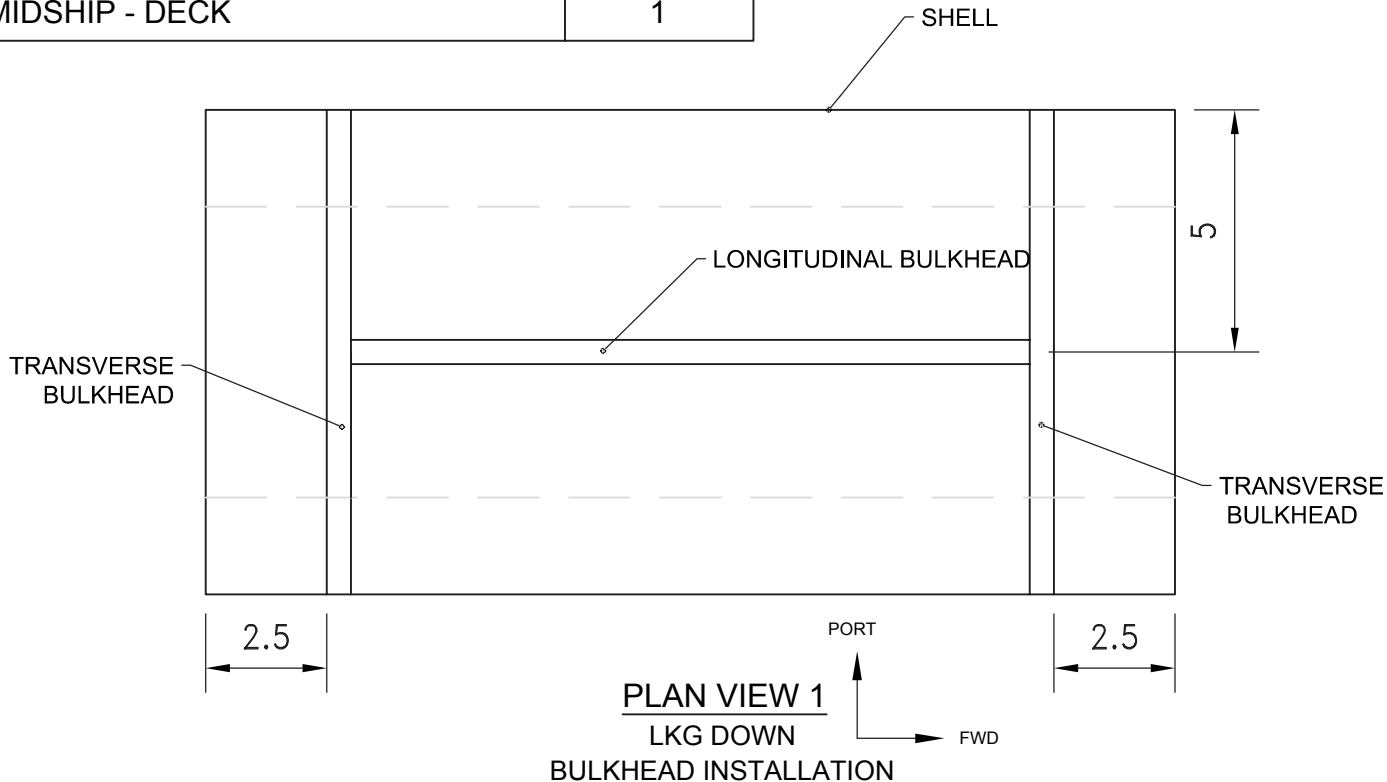

**PLAN VIEW 2**  
LKG DOWN

 <b>STEM CLASS</b> <b>SHIP 1</b>	DWN	K. JACKMAN	CHK	C. BANKS
	UNITS	MILLIMETERS	SCALE	TS    SIZE    D
	SHEET	1	DATE	2018-10-29
	DWG NO	A01-MIDSHIP PACKAGE-005	REV	A

BILL OF MATERIALS		
NAME	QUANTITY	ATERIAL DESCRIPTION
SUPERSTRUCTURE	1	21.5X28CM BLACK PLASTIC PAPER

**NOTES:**

1. ALL DIMENSIONS IN CENTIMETERS
2. FOLD ALONG FOLD LINES, AND CUT SECTIONS AS SHOWN.
3. BRING THE BLUE CIRCLES TOGETHER, WITH THE INNER TRIANGLES ON THE INSIDE AS INDICATED. DO THE SAME WITH THE OTHER SIDE (PINK CIRCLES).

**\*DRAWING NOT TO SCALE**

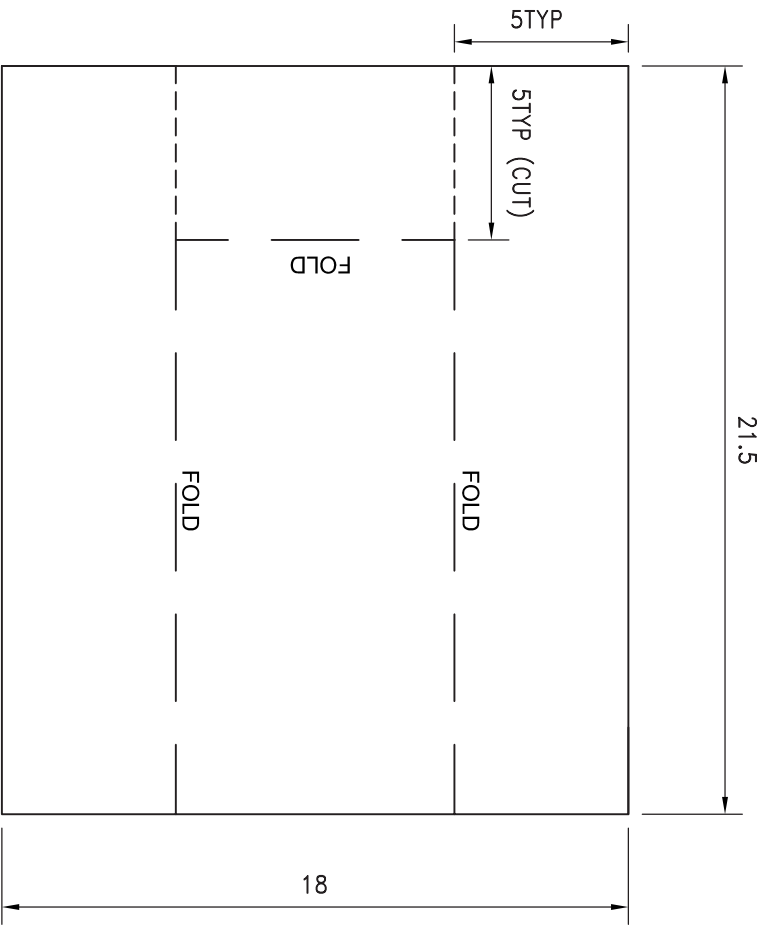

PLAN VIEW 1  
LKG DOWN  
PORT  
FWD

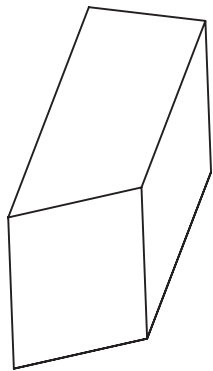

3D VIEW

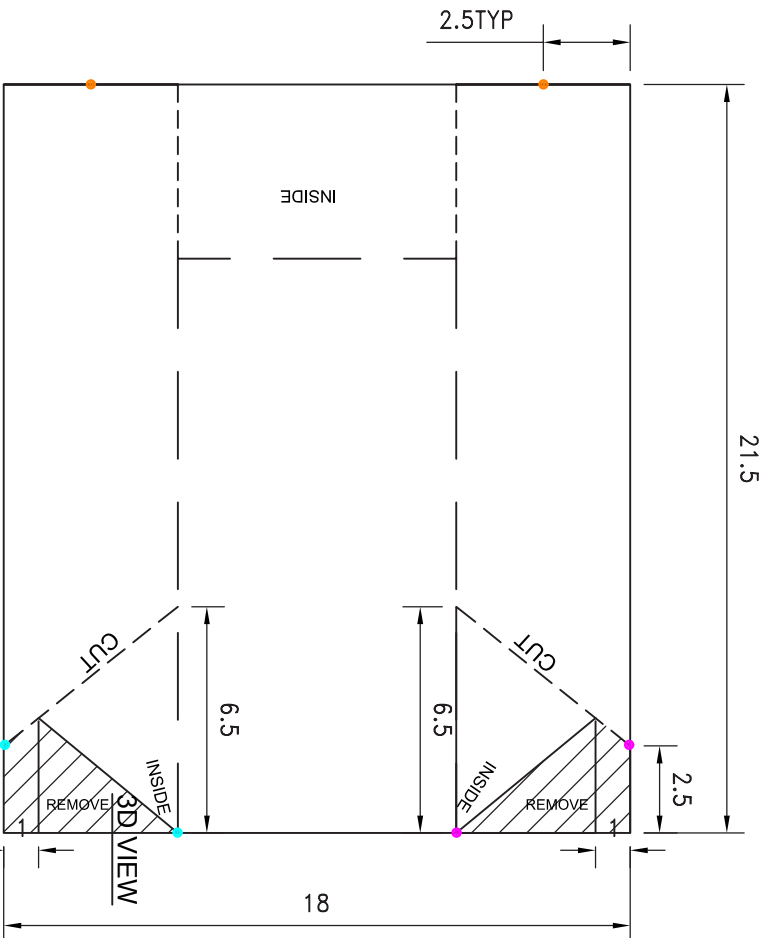

PLAN VIEW 2  
LKG DOWN  
PORT  
FWD

IRVING		ASSEMBLY DRAWING	
STEM CLASS	SHIP 1	STEM CLASS	SHIP 1
DRAWN BY	K. JACKMAN	CHECKED BY	C. BANKS
UNITS	MILLIMETERS	SCALE	NTSD
SHEET	1	DATE	2018-10-29
DWG NO.	A01-AMDSHIP PACKAGE-006	REV	A

© IRVING SHIPBUILDING INC. ALL RIGHTS RESERVED

# CONSTRUCTION OF MEGA BLOCK 3

## ACTIVITY

To Construct Bow Section of a STEM Class Ship – Mega Block 3.

## NOTES:

- Ensure optimal utilization of all materials to reduce waste.
- Ensure all cutting surfaces are protected when cutting materials with the use of a cutting board.

## MATERIAL REQUIREMENTS:

Sharpie  
Clear Ruler  
Exacto Knife  
Cutting Board  
Foam Board  
Black Plastic Sheets  
Scissors  
Glue Gun

## DEFINITIONS AND ACRONYMS:

### Definitions:

**Bulkhead** - A dividing wall or barrier between compartments in a ship

**Deck** – A structure approximately horizontal, extending across a ship

**Longitudinal** – Situated along the length of the ship

**Port** - The left side of the ship

**Shell** - The outer most structure of a ship

**Starboard** – The right side of the ship

**Stern** - The back most part of the ship

**Transverse** - Situated across the width of the ship

### Acronyms:

**DWG** - Drawing

**FWD** - Forward

**LKG FWD** - Looking Forward

**LKG DOWN** – Looking Down

**LKG PORT** – Looking Port

**PS** – Port Side

**STBD** – Starboard

**TYP** - Typical, meaning the same on both sides

## STEPS:

### 1 Bow – Transverse Bulkhead

**1.1** Using Plan 1 (p.81) measure, mark-up and cut out section of Foam Board using an Exacto Knife to the exact measurements stipulated on the drawing.

### 2. Bow – Longitudinal Bulkhead

**2.1** Using Plan 2 (p.82) measure, mark-up and cut out section of Foam Board using an Exacto Knife to the exact measurements stipulated on the drawing.

### 3. Bow – Deck

**3.1** Using Plan 3 (p.83) measure, mark-up and cut out section of Foam Board using an Exacto Knife to the exact measurements stipulated on the drawing.

### 4. Bow - Shell

**4.1** Using Plan 4 (p.84) follow the 'NOTES' section to mark-up, fold and cut Black Plastic Paper using Scissors to the exact measurements stipulated on the drawing.

**4.2** Use Glue Gun to secure sections.

### 5. Bow - Assembly

**5.1** Using Plan 5 (p.85) assemble Transverse Bulkhead, Longitudinal Bulkhead, Deck & Shell to form Mega Block 3.

**5.2** Use Glue Gun to secure sections.



BILL OF MATERIALS		
NAME	QUANTITY	MATERIAL DESCRIPTION
BOW - TRANSVERSE BULKHEAD	1	0.5CM THICK FOAM BOARD

NOTES:  
 1. ALL DIMENSIONS IN CENTIMETERS  
 \*DRAWING NOT TO SCALE

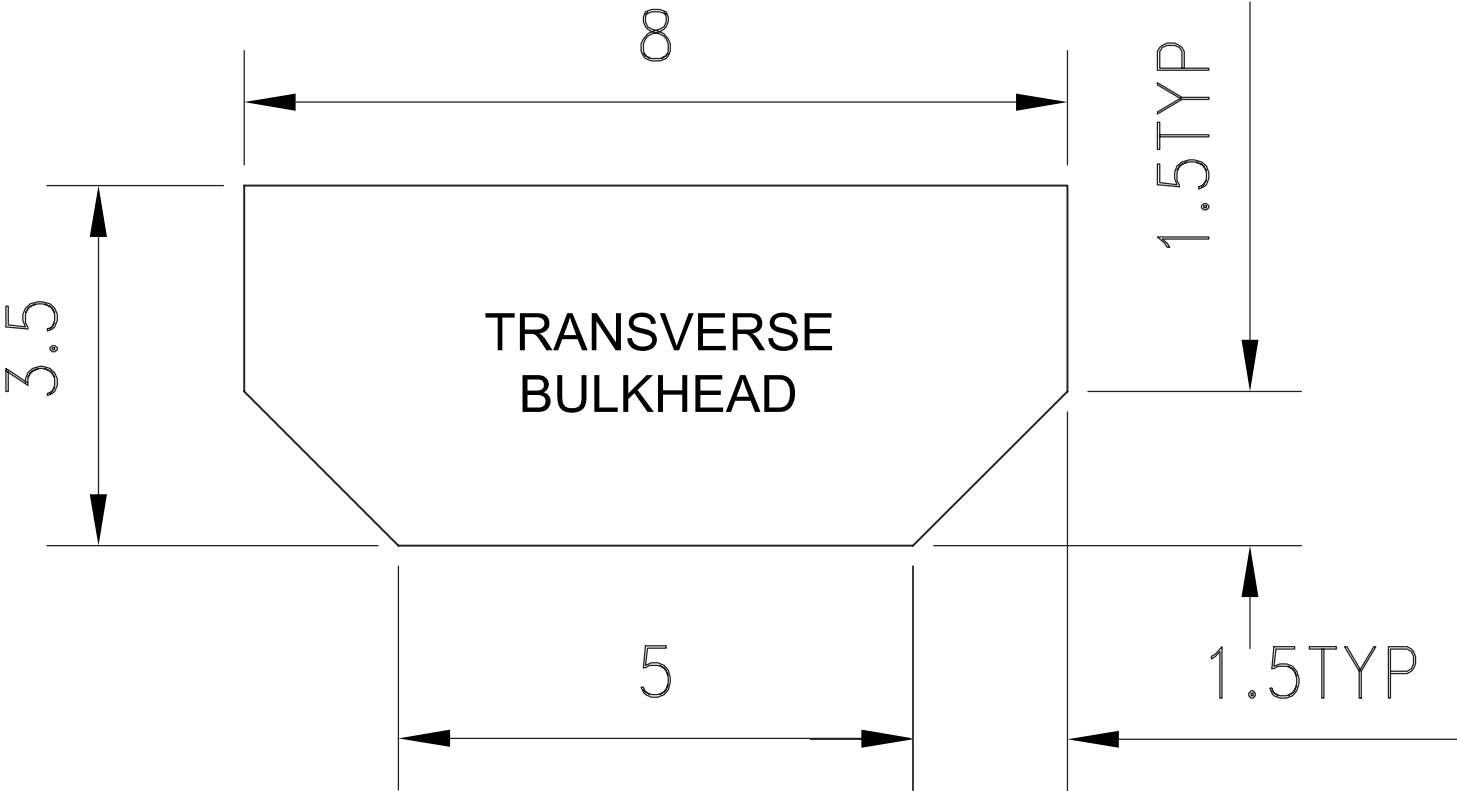

**SECTION**  
**LKG FWD**

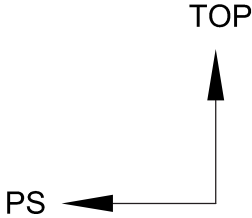

	FABRICATION DRAWING BOW - TRANSVERSE BULKHEAD MEGA BLOCK 3			
	DWN	K. JACKMAN	CHK	C. BANKS
	UNITS	MILLIMETERS	SCALE	NTSD
	SHEET	1	DATE	2018-10-29
SHIP 1	DWG NO	A01-BOW PACKAGE-001	REV	A

© IRVING SHIPBUILDING INC. ALL RIGHTS RESERVED

BILL OF MATERIALS		
NAME	QUANTITY	MATERIAL DESCRIPTION
BOW - LONGITUDINAL BULKHEAD	1	0.5CM THICK FOAM BOARD

NOTES:

1. ALL DIMENSIONS IN CENTIMETERS

\*DRAWING NOT TO SCALE

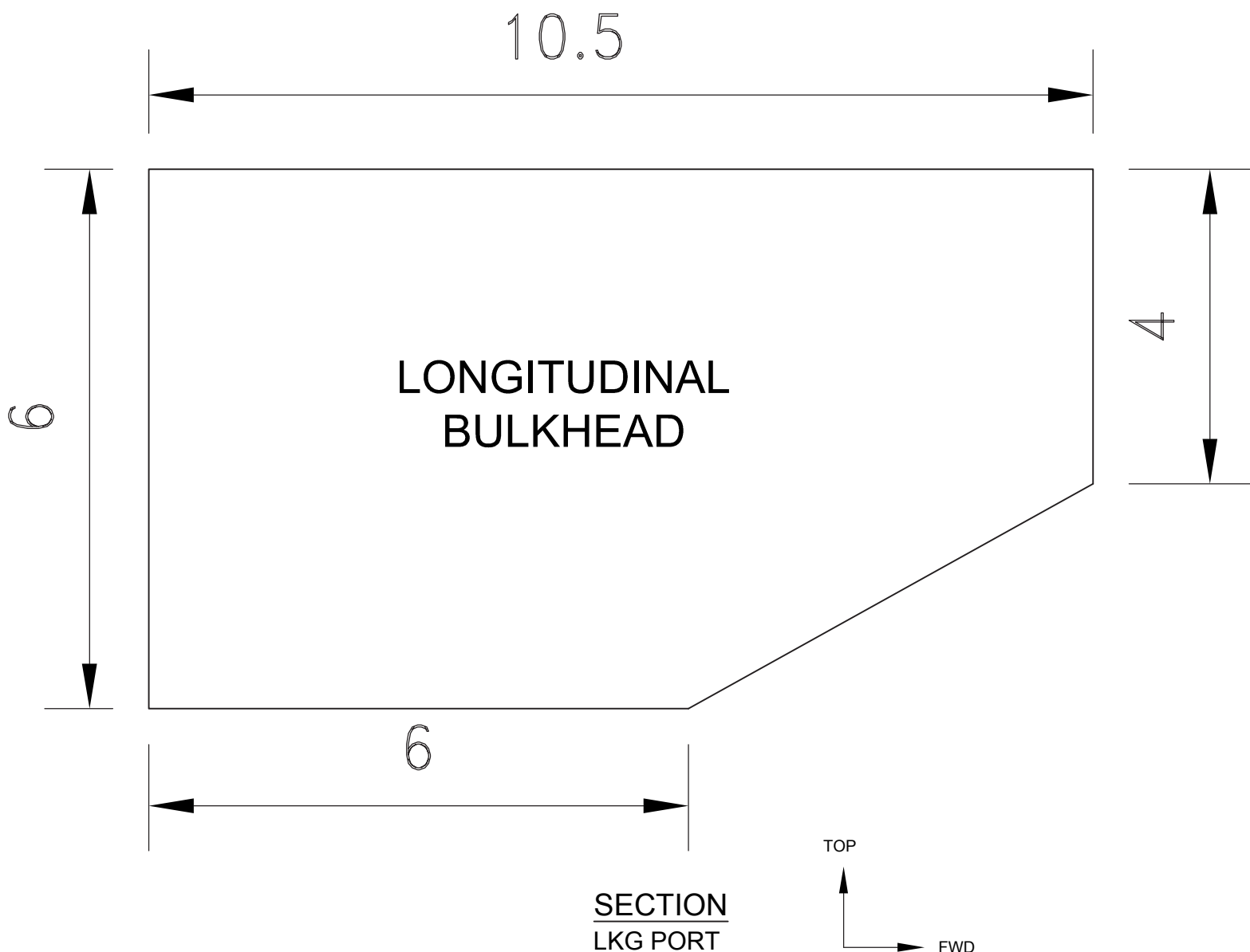

 <small>Irving Shipbuilding Inc.</small>	FABRICATION DRAWING BOW - LONGITUDINAL BULKHEAD MEGA BLOCK 3			
	DWN	K. JACKMAN	CHK	C.BANKS
STEM CLASS	UNITS	MILLIMETERS	SCALE	NTS
SHIP 1	SHEET	1	DATE	2018-10-29
	DWG NO	A01-BOW PACKAGE-002		REV
			A	

BILL OF MATERIALS		
NAME	QUANTITY	MATERIAL DESCRIPTION
BOW - DECK	1	0.5CM THICK FOAM BOARD

NOTES:  
 1. ALL DIMENSIONS IN CENTIMETERS  
 \*DRAWING NOT TO SCALE

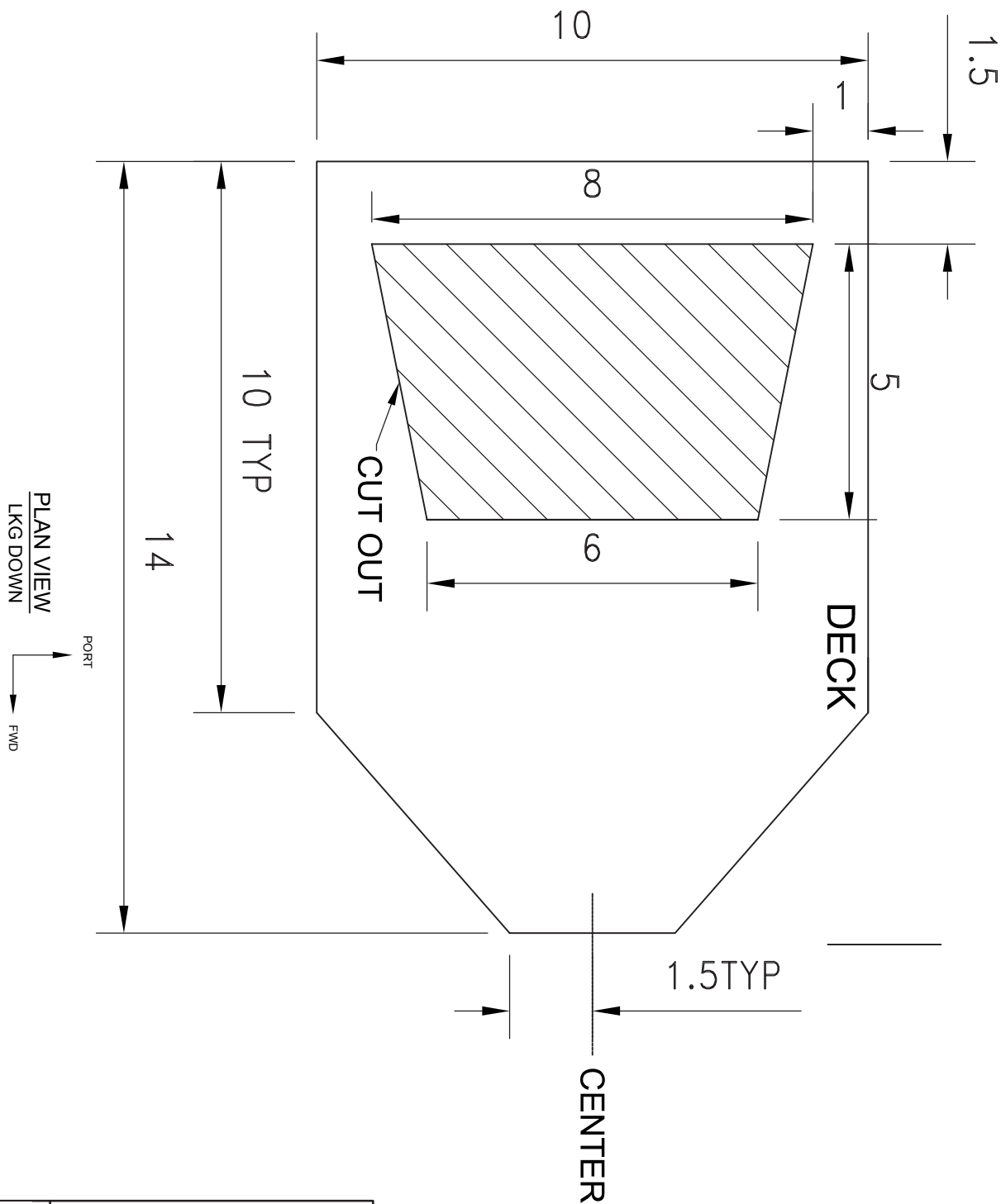

 <b>STEM CLASS</b>  <b>SHIP 1</b>	FABRICATION DRAWING BOW - DECK MEGA BLOCK 3			
	DWN	K. JACKMAN	CHK	C. BANKS
	UNITS	MILLIMETERS	SCALE	NTS SIZE D
	SHEET	1	DATE	2018-10-29
	DWG NO	A01-BOW PACKAGE-003		REV A

© IRVING SHIPBUILDING INC. ALL RIGHTS RESERVED

BILL OF MATERIALS		
NAME	QUANTITY	MATERIAL DESCRIPTION
BOW - SHELL	1	21.5X28CM BLACK PLASTIC PAPER

- NOTES:  
 1. ALL DIMENSIONS IN CENTIMETERS  
 2. DRAW FOLD LINES AND CUT LINES.  
 3. CUT ALONG CUT LINE.  
 4. BRING THE CORNERS MARKED WITH A CIRCLE TOGETHER TO OVERLAP. WITH THE MIDDLE SECTION, THE MIDDLE SECTION SHOULD BE ON THE OUTSIDE. STAPLE THESE 3 POINTS TOGETHER FIRST, THEN GLUE.

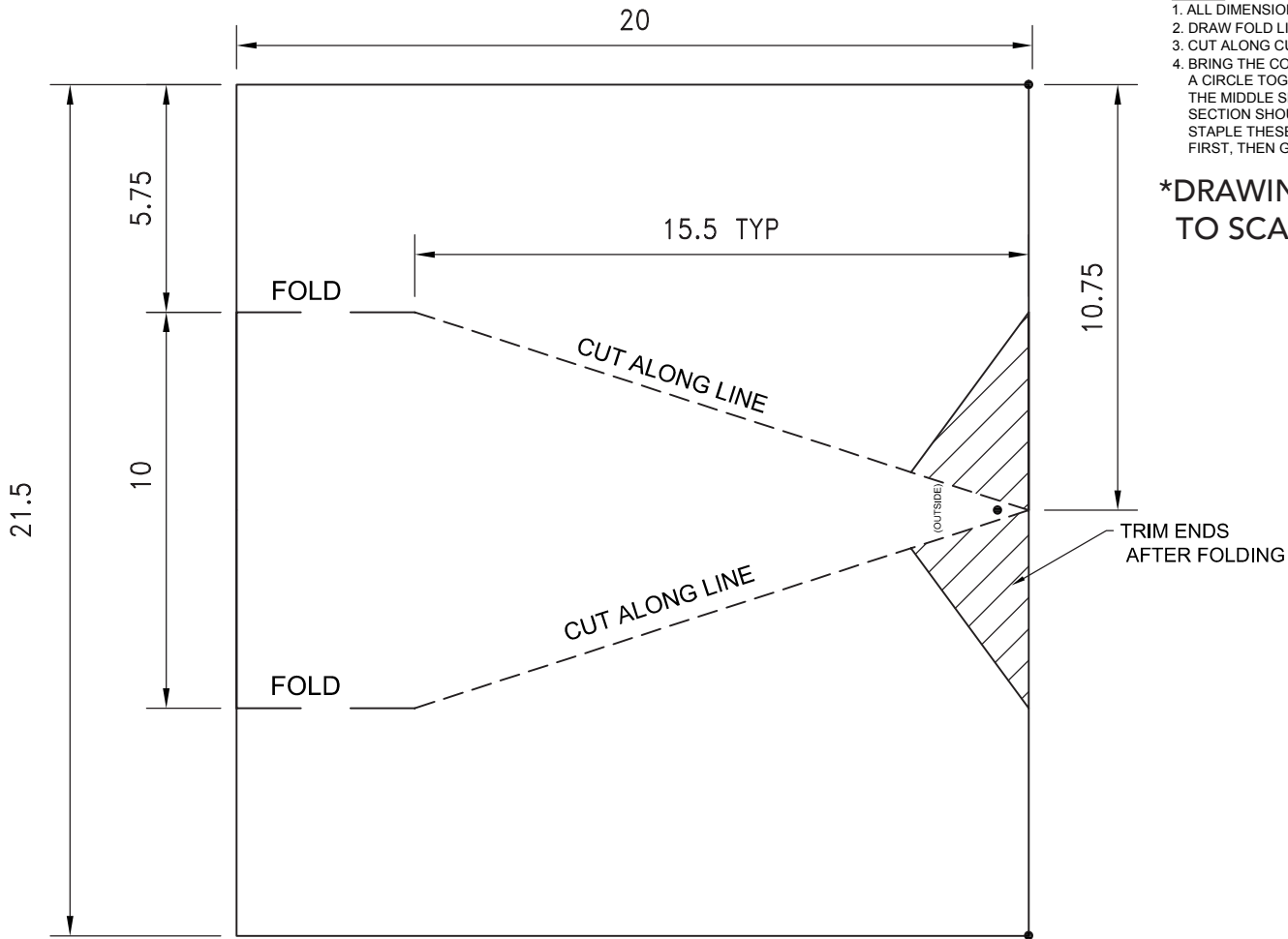

**PLAN VIEW 1**  
LKG DOWN UNFOLDED

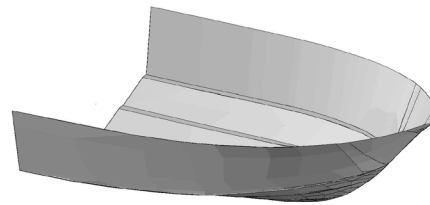
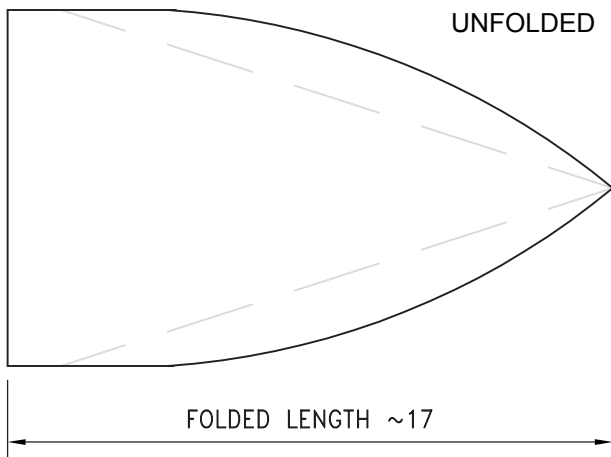
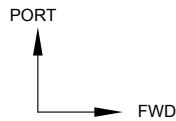

**3D VIEW**

**PLAN VIEW 2**  
LKG DOWN UNFOLDED

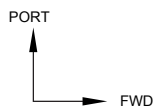

FWD

 IRVING <small>Irving Shipbuilding Inc.</small>	<b>FABRICATION DRAWING</b> <b>BOW - SHELL</b> <b>MEGA BLOCK 3</b>			
	DWN	K. JACKMAN	CHK	C. BANKS
<b>STEM CLASS</b>	UNITS	MILLIMETERS	SCALE	NTS
	SHEET	1	DATE	2018-10-29
<b>SHIP 1</b>	DWG NO	A01-BOW PACKAGE-004		REV
				A

© IRVING SHIPBUILDING INC. ALL RIGHTS RESERVED

PARTS LIST	
NAME	QUANTITY
BOW - SHELL	1
BOW - LONGITUDINAL BULKHEAD	1
BOW - TRANSVERSE BULKHEAD	1
BOW - DECK	1

**NOTES:**

1. ALL DIMENSIONS IN CENTIMETERS
2. TRIM BOTTOM PART OF BULKHEADS TO SUIT CURVATURE OF THE SHELL IF NEEDED.
3. TRIM THE DECK TO SUIT THE CURVATURE OF THE SHELL.

**\*DRAWING NOT TO SCALE**

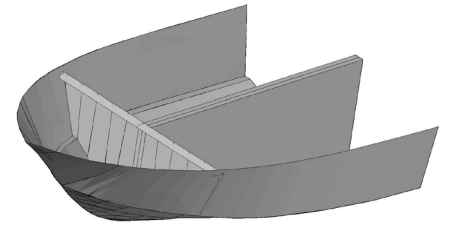
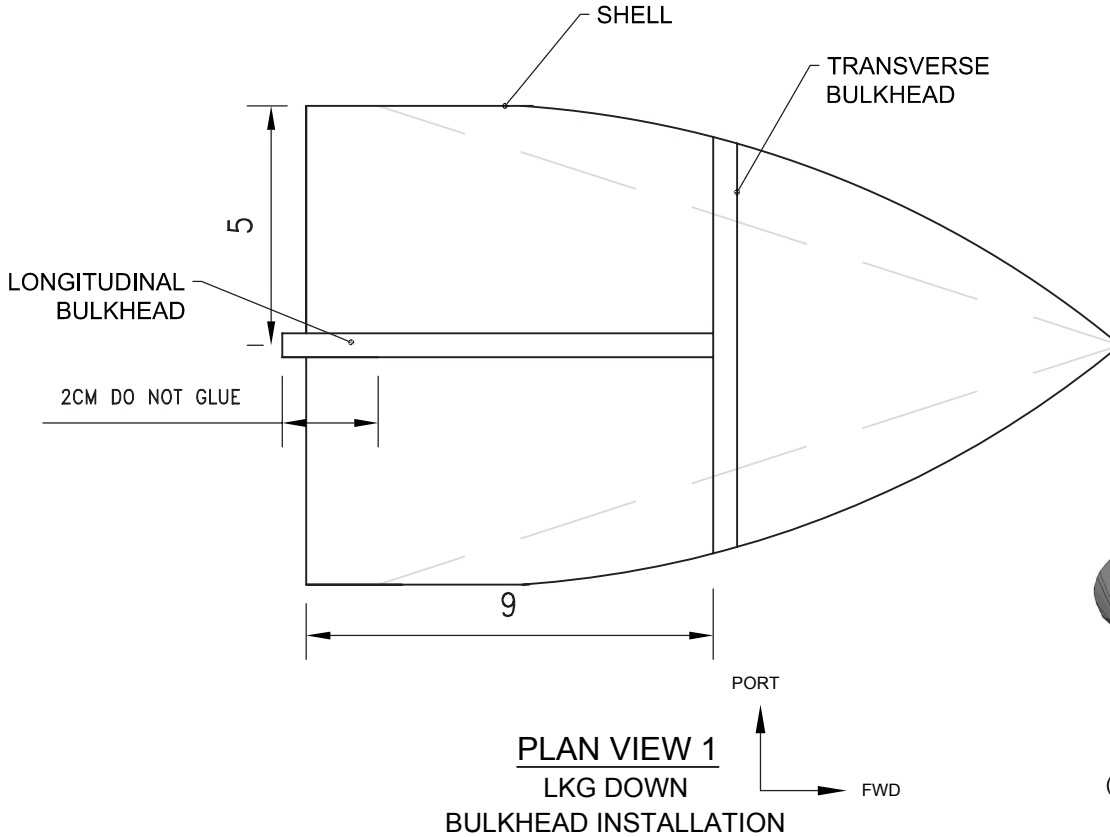

**3D VIEW**  
(DECK NOT SHOWN FOR CLARITY)

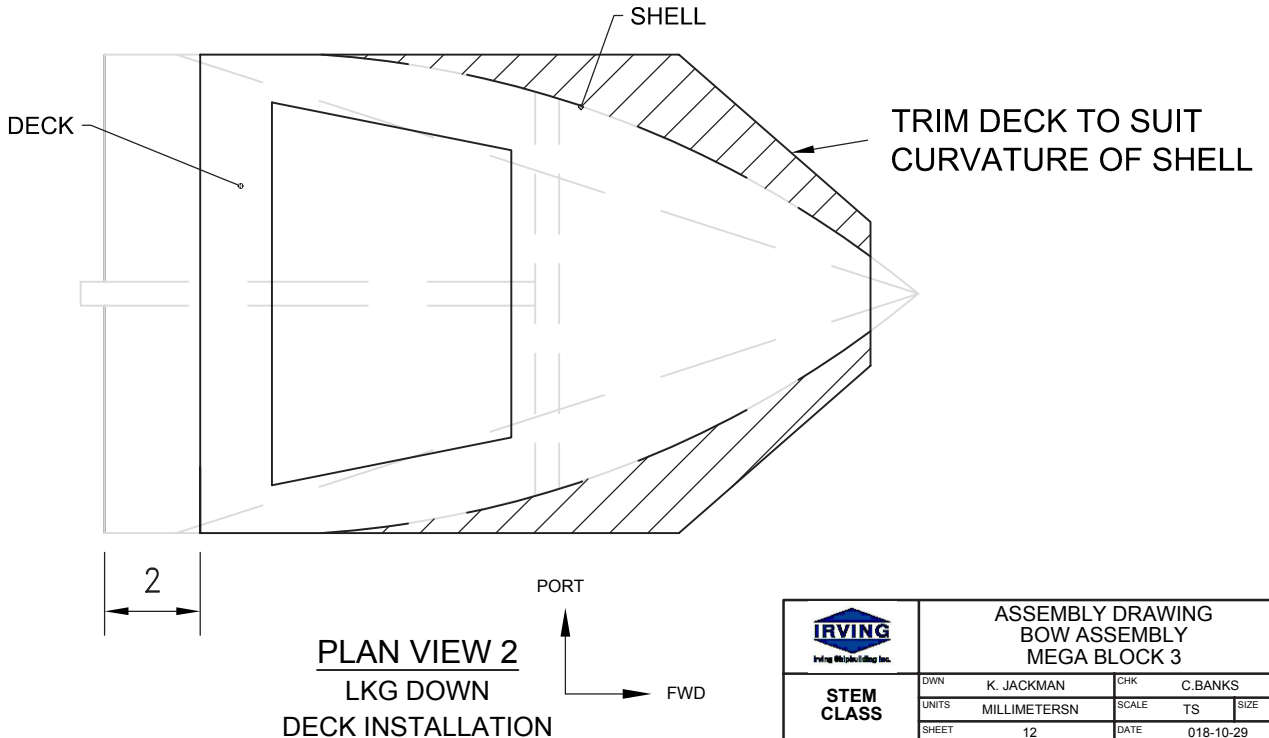

IRVING Ship Building Inc.					ASSEMBLY DRAWING BOW ASSEMBLY MEGA BLOCK 3			
DWN	K. JACKMAN	CHK	C.BANKS					
UNITS	MILLIMETERSN	SCALE	TS	SIZE	D			
SHEET	12	DATE	018-10-29					
SHIP 1	DWG NO A01-BOW PACKAGE-005			REV	A			

# FINAL ASSEMBLY

## ACTIVITY

Final Assembly of the STEM Class Ship for the Royal Canadian Navy.

## NOTES:

- Following Assembly, ship will be launched.

## MATERIAL REQUIREMENTS:

Sharpie  
Clear Ruler  
Exacto Knife  
Cutting Board  
Foam Board  
Black Plastic Sheets  
Scissors  
Glue Gun

## DEFINITIONS AND ACRONYMS:

### Definitions:

**Port:** The left side of the ship

**Super Structure:** The parts of a Ship other than Mast, built above its Hull and Main Deck

**Shell:** The outer most structure of a ship

**Mast:** A long pole that rises vertically from a ship

### Acronyms:

**DWG** - Drawing

**LKG DOWN** – Looking Down

**LKG PORT** – Looking Port

**FWD** – Forward

## STEPS:

### 1 Assembly

**1.1** Using the Plan (p.87) (follow the 'NOTES' section to assemble STEM Class Ship 1.

**1.2** Use Glue Gun to secure sections.

**1.3** Use Duct Tape to seal edges.

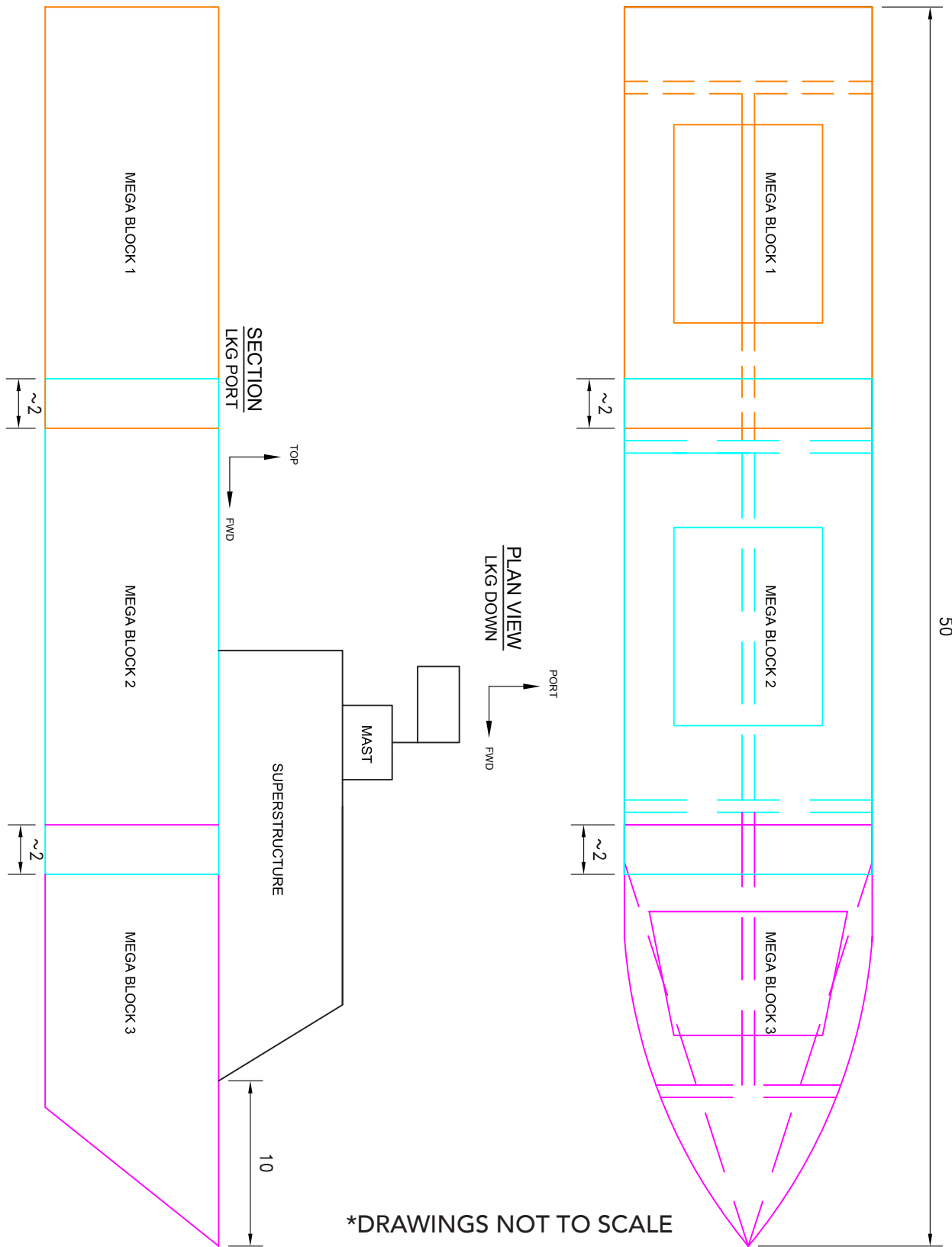

**NOTES:**

1. ALL DIMENSIONS IN CENTIMETERS
2. OVERLAP THE MEGA BLOCK SHELLS TO GET A FULL SHIP LENGTH OF 50CM. OVERLAP'S ARE APPROXIMATELY 2CM.
3. MAY NEED TO TRIM DECKS AND OR LONGITUDINAL BULKHEADS TO FIT MEGA BLOCKS TOGETHER.
3. DO NOT GLUE THE SUPERSTRUCTURE ON, LIGHTLY TAPE IT. YOU WILL NEED TO BE ABLE TO REMOVE THE SUPERSTRUCTURE TO ADD WEIGHT INSIDE.

 <p><b>STEM CLASS</b></p> <p><b>SHIP 1</b></p>	<p>ASSEMBLY DRAWING MEGA BLOCK JOIN SHIP 1</p>					
	DWN	K. JACKMAN	CHK	C. BANKS		
	UNITS	MILLIMETERSN	SCALE	TS	SIZE	D
	SHEET	1	DATE	2018-10-29	REV	A
DWG NO	A01-MEGA BLOCK PACKAGE-001			REV	A	

© IRVING SHIPBUILDING INC. ALL RIGHTS RESERVED



# FACILITATOR GUIDE FOR STUDENT'S DESIGN THINKING

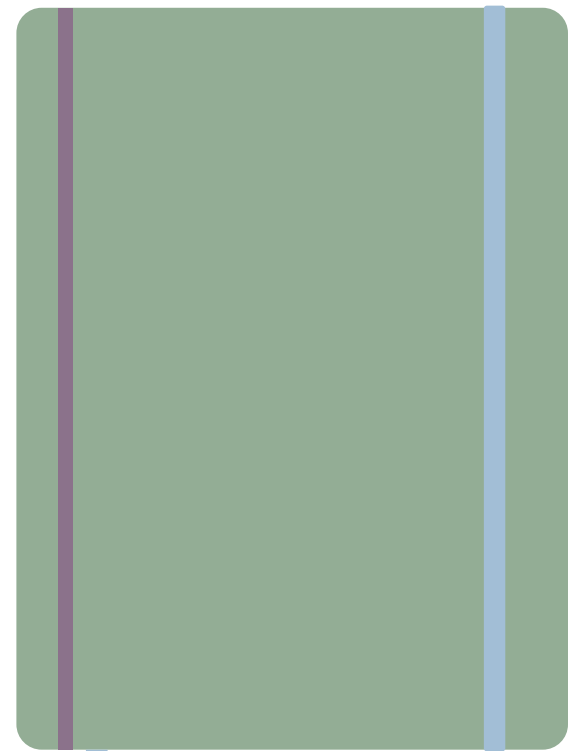
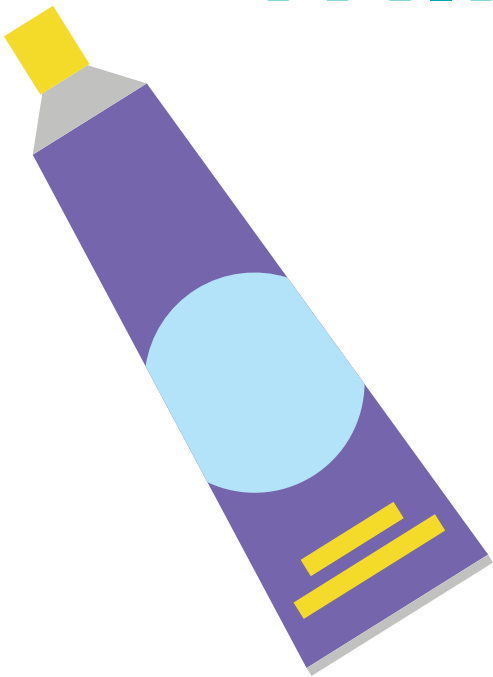
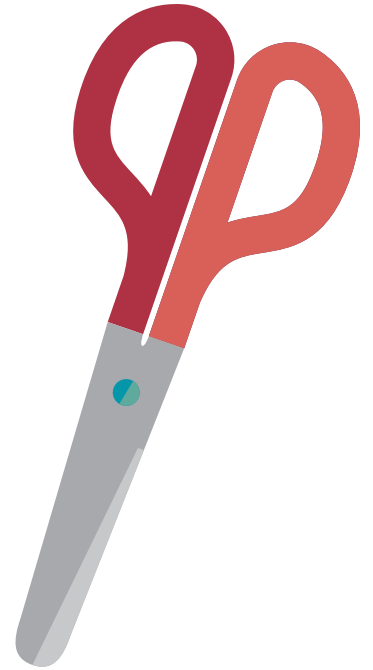

# FACILITATOR GUIDE FOR STUDENT'S DESIGN THINKING

Design Challenge: *Title of your chosen Design Challenge*

## Items Needed:

- Copies of the Design Challenge
- Copies of the Fillable Student Workbook (p.68) and Placemat (p.70) printed on Tabloid (11x17) paper
- Pencils for each student
- Participant kit

1. Make sure you have all the students in your group at your table or workstation.
2. Make sure you have your participant kit – there is one per group. Contents of this kit should NOT be shared with the students until Section #4 Build a Prototype of this Design Thinking process.
3. Make sure you have a digital timing device.
4. Read the Design Challenge to your group. Ask the students if there are any terms, words, or ideas that need clarification.
5. Hand a copy of both the Workbook and Placemat to each student. Make sure everyone has a pencil.
6. Ask the students to fold the Workbook into a booklet. The Maker Day host will show you how.
7. Ask the students to read the first page entitled Your Task.
8. Ask if there are any questions about the task. Review the following sections from the Design Challenge: **Success Determinants** and **Parameters**.
9. Ask the students to answer the three questions in their Workbook (5 mins)
  1. What is the purpose of the design challenge?
  2. What do the key terms mean?
  3. Why is the challenge important?
10. Briefly discuss their answers.

## FACILITATOR GUIDE FOR STUDENT'S DESIGN THINKING

11. Turn to Section #1 Gain Empathy. Discuss briefly what empathy is and how it is different from sympathy. Ask the student to do Part A - Write 3 -5 questions you can ask people to learn more about them as users of the challenge. They can write these questions in their Workbook. (5 mins)
12. Now, ask them to pick a partner at their table and use their questions to interview that person. Part B asks them to record the responses in words on Section 1 on their Placemats and Part C ask them to sketch on the back page of their Workbook after their interviews. (5 mins for each interview; 3 mins to record and sketch)
13. Turn to Section #2 Define the Problem. Have the students identify who they are designing their component for – Section A. Then have them complete Section B - What is your person's need? Remind your group to complete Section #2 on their Placemats by recording who they are designing for and what that person may need that will have to be considered in the design. (3 mins)
14. Turn to Section #3 Brainstorm. Stress the points in bold in their Workbooks - **DEFER JUDGEMENT, GO FOR VOLUME, ONE CONVERSATION AT A TIME, BE VISUAL, THINK HEADLINES, BUILD ON THE IDEAS OF OTHERS, STAY ON TOPIC, ENCOURAGE WILD IDEAS**
15. Ask them to start by sketching 6 ideas of their own. These are to be detailed sketches. (10 mins)
16. Once the brainstorm sketching is done, ask the students to share their sketches with their partners from Section #1 Gain Empathy. The students ask for feedback on their sketches. The students record the feedback on Section #3 on their Placemats (leaving some room to add their modified sketch [#17 below]). (5 mins for each person to share and receive feedback)
17. Based on the feedback, ask the students to modify 1 of their sketches that they would like to take to the prototype stage. This modified sketch is added to Section #3 on the Placemat. (5 mins)

## FACILITATOR GUIDE FOR STUDENT'S DESIGN THINKING

18. Turn to Section #4 Build a Prototype in the Workbook. Discuss the difference between a prototype and a working model. Discuss the reason(s) why building is important. Everyone takes turns and shares Sections # 2 and 3 on their Placemat. Then the group negotiates which ideas / sketch they think they would build collectively into a prototype. When a sketch is agreed upon (might be one person's sketch or a combination of the group's ideas), show the contents of the participant kit. Discuss whether the selected sketch needs to be modified because of either the materials in the kit or other thoughts / ideas the participants have. If the sketch changes, make sure the group re-sketches the design. Record the group's design (words and sketch) on #4 of their Placemats. (approximately 10 – 15 mins)
19. Check out the pantry and tool crib with your group, and then start to build your group's prototype. (2 – 3 hours)
20. Prepare for the Gallery Tour ... make sure each student has a finalized sketch of the prototype. During the gallery tour, one student stays with the prototype and answers questions, the other students tour and explore the other groups' prototypes. Make sure you have a plan for the students to trade off in terms of who is touring and who is staying back. (30 mins)
21. Following the Gallery Tour, have the group discuss the Table in Section #5 in their Workbooks (likes, changes, questions people had, new ideas). This is the group reflection. After the discussion, have students sketch an improved prototype version in Section #5 on their Placemats individually. (5 mins)
22. Turn to Section #6 Reflect. Each student answers the questions and records them on their Placemats in Section #6.
23. Make sure you clean up your table and area and return all items that are reusable to the pantry and tool crib. Congratulations on a job well done!



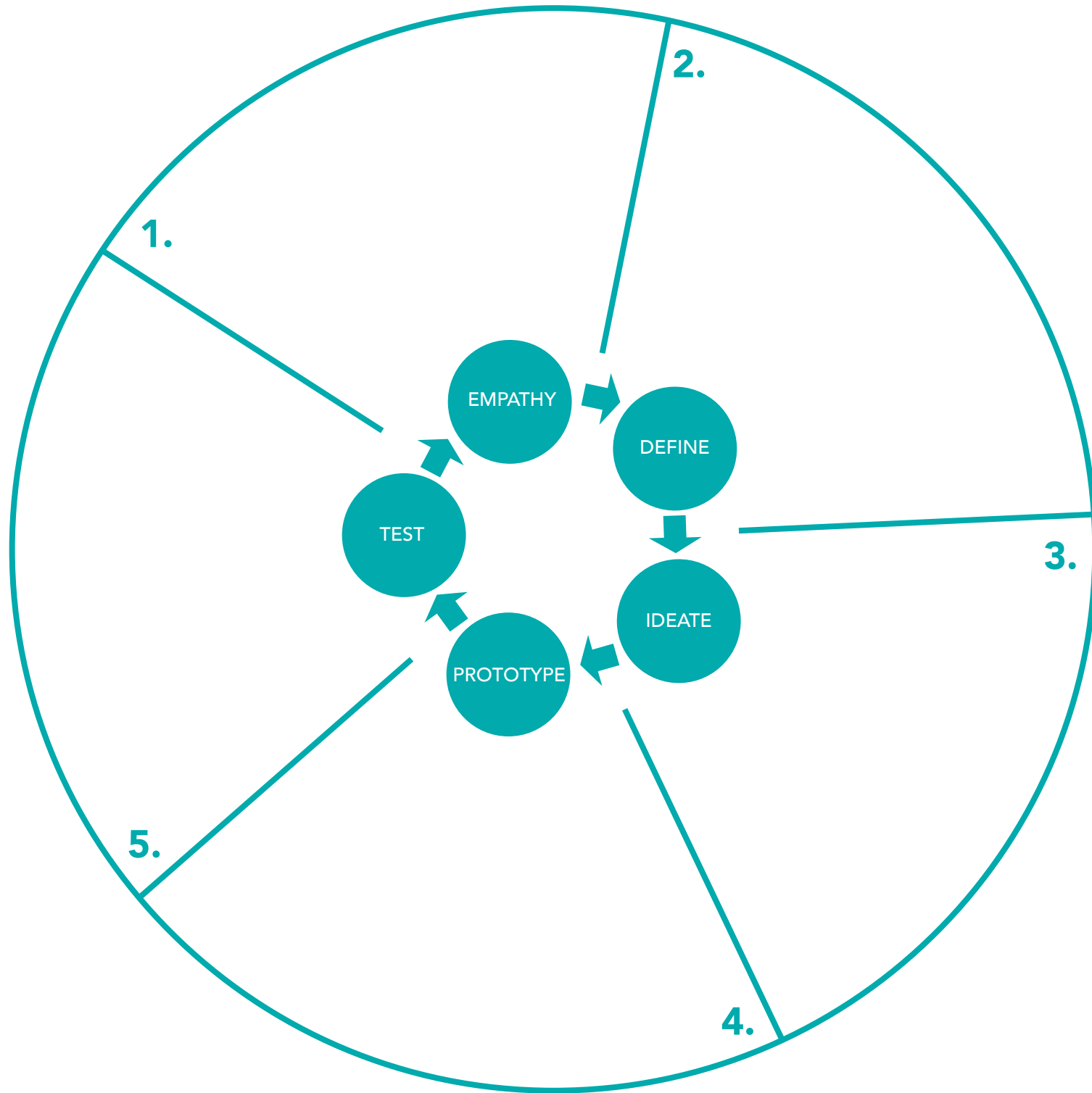

**6.**

A large empty rectangular box with a teal border, intended for student notes or reflections.
